

KENWOOD

KDC-X969

KDC-X869

KDC-MP922

CD-RECEIVER

INSTRUCTION MANUAL

KENWOOD CORPORATION



Take the time to read through this instruction manual.

Familiarity with installation and operation procedures will help you obtain the best performance from your new CD-receiver.

For your records

Record the serial number, found on the back of the unit, in the spaces designated on the warranty card, and in the space provided below. Refer to the model and serial numbers whenever you call upon your KENWOOD dealer for information or service on the product.

Model KDC-X969, KDC-X869, KDC-MP922 Serial number _____

© B64-2458-00/01 (KV)

Contents

Safety precautions	4		
About RDS	5		
About Sirius Satellite radio tuner	5		
Notes on playing MP3/WMA	6		
Notes on Multi-function Key System	8		
About CDs	9		
General features	10		
Power		Direct Access Tuning	
Selecting the Source		Station Preset Memory	
Volume		Auto Memory Entry	
Attenuator		Preset Tuning	
Panel Position Setting		SNPP (Station Name Preset Play)	
System Q		RDS features	30
Non-fading Output		Radio Text Scroll	
Speaker Setting		PTY (Program Type)	
Audio Control		Registration of a station as a PTY	
Display Mode Switching		Program Type preset	
Right Side Graphic Display Switching		CD/MP3/WMA/External disc control features	32
Wallpaper selecting		Playing CD & MP3/WMA	
Graphic part/ Spectrum Analyzer & Text Display Switching		Playing External Disc	
Left Side Graphic Display Switching		Fast Forwarding and Reversing	
Text Display Switching		Track/File Search	
Switching the Standby Display		Disc/ Folder Search	
Font Color Select		Direct Track/File Search	
Station/Disc Naming (SNPS/DNPS)		Direct Disc Search	
Auxiliary Input Display Setting		Track/File/Disc/Folder Repeat	
Theft Deterrent Panel		Scan Play	
Hiding the Control Panel		Random Play	
Dual Zone System		Magazine Random Play	
Tuner features	27	Text/Title Scroll	
Tuning Mode		DNPP (Disc Name Preset Play)	
Tuning		Folder Select	
		Sirius tuner control features	37
		Select Sirius Satellite Radio Mode	
		Switching Seek Mode	
		Channel/Category Search	
		Direct Access Tuning	
		Selecting the Preset Band	
		Channel Preset Memory	
		Preset Tuning	
		Channel Scan	
		Text Scroll for Sirius tuner source	
		Menu system	40
		Menu System	
		Security Code	
		Touch Sensor Tone	
		Manual Clock Adjustment	
		Date Adjustment	
		Date Mode	
		Synchronize Clock	
		DSI (Disabled System Indicator)	
		Selectable Illumination	
		Font Type Select	
		Dimmer	
		OFF Wait Time Setting	
		Eject angle setting	
		System Q Setting	
		Built-in Amp Mute Setting	
		B.M.S. (Bass Management System)	
		B.M.S. Frequency Offset	
		Traffic Information	
		CRSC (Clean Reception System Circuit)	
		Sirius ID [ESN] display	
		Text Scroll	
		Built-in Auxiliary input Setting	
		CD Read Setting	
		Picture downloading	
		Basic Operations of remote	47
		Accessories	49
		Installation Procedure	49
		Connecting Wires to Terminals	50
		Installation	51
		Removing the Unit	52
		Locking the Backpanel to the unit .	53
		Troubleshooting Guide	54
		Specifications	58

▲ Warning

▲ CAUTION

Use of controls or adjustments or performance of procedures other than those specified herein may result in hazardous radiation exposure.

In compliance with Federal Regulations, following are reproductions of labels on, or inside the product relating to laser product safety.

KENWOOD CORPORATION
2967-3, ISHIKAWA-CHO,
HACHIOJI-SHI
TOKYO, JAPAN

KENWOOD CORP. CERTIFIES THIS EQUIPMENT
CONFORMS TO DHHS REGULATIONS NO.21 CFR
1040. 10, CHAPTER 1, SUBCHAPTER J.

Location : Bottom Panel

FCC WARNING

This equipment may generate or use radio frequency energy. Changes or modifications to this equipment may cause harmful interference unless the modifications are expressly approved in the instruction manual. The user could lose the authority to operate this equipment if an unauthorized change or modification is made.

NOTE

This equipment has been tested and found to comply with the limits for a Class B digital device, pursuant to Part 15 of the FCC Rules. These limits are designed to provide reasonable protection against harmful interference in a residential installation. This equipment may cause harmful interference to radio communications, if it is not installed and used in accordance with the instructions. However, there is no guarantee that interference will not occur in a particular installation. If this equipment does cause harmful interference to radio or television reception, which can be determined by turning the equipment off and on, the user is encouraged to try to correct the interference by one or more of the following measures:

- Reorient or relocate the receiving antenna.
- Increase the separation between the equipment and receiver.
- Connect the equipment into an outlet on a circuit different from that to which the receiver is connected.
- Consult the dealer or an experienced radio/TV technician for help.

NOTE

This Class B digital apparatus complies with Canadian ICES-003.

Safety precautions

▲WARNING

To prevent injury or fire, take the following precautions:

- Insert the unit all the way in until it is fully locked in place. Otherwise it may fall out of place when jolted.
- When extending the ignition, battery, or ground wires, make sure to use automotive-grade wires or other wires with a 0.75mm² (AWG18) or more to prevent wire deterioration and damage to the wire coating.
- To prevent a short circuit, never put or leave any metallic objects (such as coins or metal tools) inside the unit.
- If the unit starts to emit smoke or strange smells, turn off the power immediately and consult your Kenwood dealer.
- Make sure not to get your fingers caught between the faceplate and the unit.
- Be careful not to drop the unit or subject it to strong shock.
The unit may break or crack because it contains glass parts.

▲CAUTION

To prevent damage to the machine, take the following precautions:

- Make sure to ground the unit to a negative 12V DC power supply.
- Do not open the top or bottom covers of the unit.
- Do not install the unit in a spot exposed to direct sunlight or excessive heat or humidity. Also avoid places with too much dust or the possibility of water splashing.
- Do not subject the faceplate to excessive shock, as it is a piece of precision equipment.
- When replacing a fuse, only use a new one with the prescribed rating. Using a fuse with the wrong rating may cause your unit to malfunction.
- To prevent a short circuit when replacing a fuse, first disconnect the wiring harness.
- Do not place any object between the faceplate and the unit.
- Do not use your own screws. Use only the screws provided. If you use the wrong screws, you could damage the unit.
- Do not apply excessive force to the moving faceplate. Doing so will cause damage or malfunction.
- Do not apply excessive force to the open faceplate or place objects on it. Doing so will cause damage or breakdown.

IMPORTANT INFORMATION

About CD players/disc changers connected to this unit

KENWOOD disc changers/ CD players released in 1998 or later can be connected to this unit.

Refer to the catalog or consult your Kenwood dealer for connectable models of disc changers/ CD players.

Note that any KENWOOD disc changers/ CD players released in 1997 or earlier and disc changers made by other makers cannot be connected to this unit.

Unsupported connection may result in damage.

Setting the "O-N" Switch to the "N" position for the applicable KENWOOD disc changers/ CD players.

The functions that can be used and the information that can be displayed will differ depending on the models being connected.



You can damage both your unit and the CD changer if you connect them incorrectly.

Do Not Load 3-in. CDs in the CD slot

If you try to load a 3 in. CD with its adapter into the unit, the adapter might separate from the CD and damage the unit.

WOW, SRS and the  symbol are trademarks of SRS Labs, Inc.
WOW technology is incorporated under license from SRS Labs, Inc.

NOTE

- If you experience problems during installation, consult your Kenwood dealer.
- If the unit fails to operate properly, press the Reset button. The unit returns to factory settings when the Reset button is pressed. If the unit still fails to operate properly after the Reset button has been pressed, contact your local KENWOOD dealer for assistance.
- Press the reset button if the disc auto changer fails to operate correctly. Normal operation should be restored.

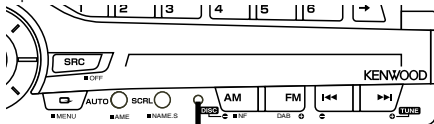

Reset button

- We recommend the use of <Security Code> (page 40) to prevent theft.
- The illustrations of the display and the panel appearing in this manual are examples used to explain more clearly how the controls are used. Therefore, what appears on the display in the illustrations may differ from what appears on the display on the actual equipment, and some of the illustrations on the display may represent something impossible in actual operation.
- There are places in this manual where lit indicators are described; however, the only time an indicator will light is in the following settings.
KDC-X969: at <Text Display Switching> (page 20), when the lower text display part is set to "CLOCK".
KDC-X869/KDC-MP922: when Display Mode is set to "Display Type A".

Lens Fogging

Right after you turn on the car heater in cold weather, dew or condensation may form on the lens in the CD player of the unit. Called lens fogging, CDs may be impossible to play. In such a situation, remove the disc and wait for the condensation to evaporate. If the unit still does not operate normally after a while, consult your Kenwood dealer.

Cleaning the Faceplate Terminals

If the terminals on the unit or faceplate get dirty, wipe them with a dry, soft cloth.

Cleaning the Unit

If the faceplate of this unit is stained, wipe it with a dry soft cloth such as a silicon cloth. If the faceplate is stained badly, wipe the stain off with a cloth moistened with neutral cleaner, then wipe neutral detergent off.



Applying spray cleaner directly to the unit may affect its mechanical parts. Wiping the faceplate with a hard cloth or using a volatile liquid such as thinner or alcohol may scratch the surface or erases characters.

Cleaning the CD Slot

As dust tends to accumulate in the CD slot, clean it every once in a while. Your CDs can get scratched if you put them in a dusty CD slot.

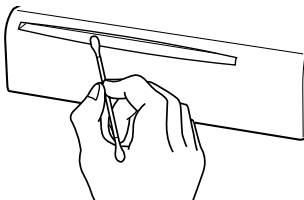

About RDS

RDS (Radio Data System)

RDS is a service used by radio stations to transmit data outside normal radio broadcast signals.

When an RDS station is received, you can immediately find out what kind of data is being transmitted by looking at the program service name, which appears in the display after the frequency.

Alarm

When an emergency transmission (announcing disasters, etc.) is made, the current function will be interrupted to allow the warning to be received under the following conditions: during tuner reception, or when the Traffic Information function is turned on.

About Sirius Satellite radio tuner

Refer to the Sirius tuner control features of this manual for the operation method of Sirius Satellite radio tuner KTC-SR901 (optional accessory) when connected.

Notes on playing MP3/WMA

This unit can play MP3(MPEG1, 2, 2.5 Audio Layer 3)/WMA. Note, however, that the MP3/WMA recording media and formats acceptable are limited. When writing MP3/WMA, pay attention to the following restrictions.

Acceptable media

The MP3/WMA recording media acceptable to this unit are CD-ROM, CD-R, and CD-RW.

When using CD-RW, do full format not quick format to prevent malfunction.

Acceptable medium formats

The following formats are available for the media used in this unit. The maximum number of characters used for file name including the delimiter (".") and three-character extension are indicated in parentheses.

- ISO 9660 Level 1 (12 characters)
- ISO 9660 Level 2 (31 characters)
- Joliet (64 characters)
- Romeo (128 characters)

Up to 200 characters can be displayed in the long file name format.

For a list of available characters, see the instruction manual of the writing software and the section Entering file and folder names below. The media reproducible on this unit has the following limitations:

- Maximum number of directory levels: 8
- Maximum number of files per folder: 255
- Maximum number of characters for folder name: 64
- Maximum number of folders: 100 (KDC-X969)
50 (KDC-X869/ KDC-MP922)

MP3/WMA written in the formats other than the above may not be successfully played and their file names or folder names are not properly displayed.

Settings for your MP3/WMA encoder and CD writer

Do the following setting when compressing audio data in MP3/WMA data with the MP3/WMA encoder.

- Transfer bit rate MP3: 8 —320 kbps
 WMA: 48 —192 kbps
- Sampling frequency
 MP3: 8, 11.025, 12, 16, 22.05, 24, 32, 44.1, 48 kHz
 WMA: 32, 44.1, 48 kHz



Play mode may not be possible when portions of the functions of Windows Media Player 9 or higher are used.

When you use your CD writer to record MP3/WMA up to the maximum disc capacity, disable additional writing. For recording on an empty disc up to the maximum capacity at once, check Disc at Once.

Entering ID3 tag and Contents Description

The Displayable ID3 tag is ID3 version 1.x.

For the character code, refer to the List of Codes.

	0	1	2	3	4	5	6	7	8	9	A	B	C	D	E	F
0				@	P											
1			!	A	Q	a	q									
2			"	B	R	b	r			e	?					
3			#	C	S	c	s			?						
4			\$	D	T	d	t			?						
5			%	E	U	e	u			?						
6			&	F	V	f	v			!						
7			'	G	W	g	w			?						
8			(H	X	h	x			?						
9)	I	Y	i	y			@						
A			*	J	Z	j	z			?						
B			+	K	[k	{			?						
C			<	L	\	l				?						
D			=	M]	m	}			@						
E			>	N	^	n	~			@						
F			?	O	_	o	~			?						

Entering file and folder names

The code list characters are the only file names and folder names that can be entered and displayed.

If you use any other character for entry, the file and folder names are not displayed correctly. They may neither be displayed correctly depending on the CD writer used.

The unit recognizes and plays only those MP3/WMA which have the MP3/WMA extension (.MP3/.WMA).



A file with a name entered with characters not on the code list may not play correctly.

Writing files into a medium

When a medium containing MP3/WMA data is loaded, the unit checks all the data on the medium. If the medium contains a lot of folders or non-MP3/WMA files, therefore, it takes a long time until the unit starts playing MP3/WMA.

In addition, it may take time for the unit to move to the next MP3/WMA file or a File Search or Folder Search may not be performed smoothly.



Loading such a medium may produce loud noise to damage the speakers.

- Do not attempt to play a medium containing a non-MP3/WMA file with the MP3/WMA extension.
The unit mistakes non-MP3/WMA files for MP3/WMA data as long as they have the MP3/WMA extension.
- Do not attempt to play a medium containing non MP3/WMA.

MP3/WMA playing order

When selected for play, Folder Search, File Search, or for Folder Select, files and folders are accessed in the order in which they were written by the CD writer.

Because of this, the order in which they are expected to be played may not match the order in which they are actually played. You may be able to set the order in which MP3/WMA are to be played by writing them onto a medium such as a CD-R with their file names beginning with play sequence numbers such as "01" to "99", depending on your CD writer.

For example, a medium with the following folder/ file hierarchy is subject to Folder Search, File Search, or Folder Select as shown below.

Example of a medium's folder/file hierarchy

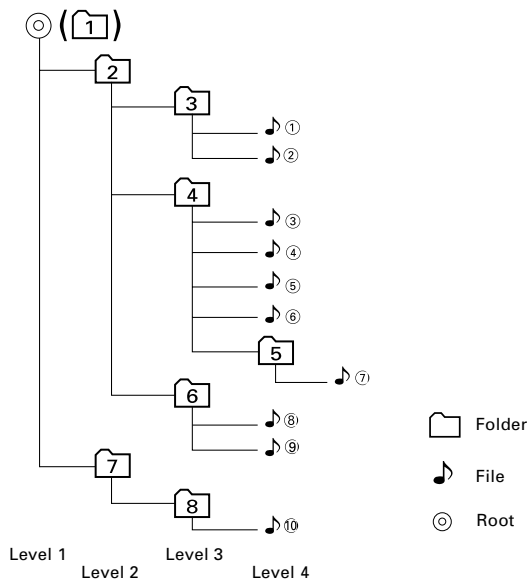

When a File Search is executed with file ④ being played ...

Current file number	Operation of the button	
	◀◀ Button	▶▶ Button
④	Beginning of file ④ ▶ ③	⑥ ▶ ⑤ ▶ ④

When a Folder Search is executed with file ④ being played ...

Current folder number	Operation of the button	
	AM Button	FM Button
④	③ ▶ ② ▶ ① ▶ ⑧ ...	⑤ ▶ ⑥ ▶ ⑦ ▶ ⑧ ▶ ① ...

When Folder Select is selected with file ④ being played to move from folder to folder ...

Current folder number	Operation of the button			
	◀◀ Button	▶▶ Button	AM Button	FM Button
④	③	⑥	②	⑤

Notes on Multi-function Key System

Multi-function Key System serves to control various functions with the [2] — [5] buttons.

The basic operation of the Multi-function Key System is described below.

What's the Multi-function Key System?

This unit is equipped with the Multi-function Key System that enables the operation of multiple functions with one button.

For example, you can enter the Display Control Mode or turn ON/OFF the Random Play by pressing the [3] button during CD play.

Setting each function

The function display will show the controllable function of the [2] — [5] button above the button.

Pressing the [2] — [5] button below the desired function enables the setting of the function.

Displaying the desired function

If five or more functions are available to be set with the [2] — [5] button, they are divided into multiple function groups (referred to as sections in this manual) for registration.

Press the [NEXT] button to switch the sections.

If the display of the desired function is not shown, press the [NEXT] button 1 to 3 times to switch the sections until the wanted function display is shown.

Example: Function display of CD & External disc source

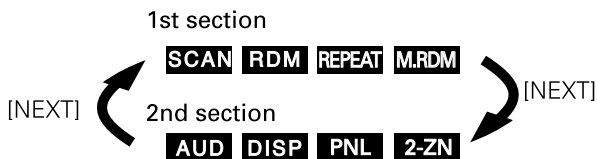

"M.RDM" is displayed when an optional accessory is connected.

Real operational example of the Multi-function Key System

Example: Turning ON/OFF the Random Play during CD play.

1. Show the function display of the Random Play.

If "RDM" is not shown in the display, press the [NEXT] button to switch the sections until the "RDM" function display is shown above the [3] button.

2. Turn ON/OFF the Random Play.

Press the [3] button.

Each time the [3] button under the "RDM" function display is pressed the Random Play is turned ON/OFF.

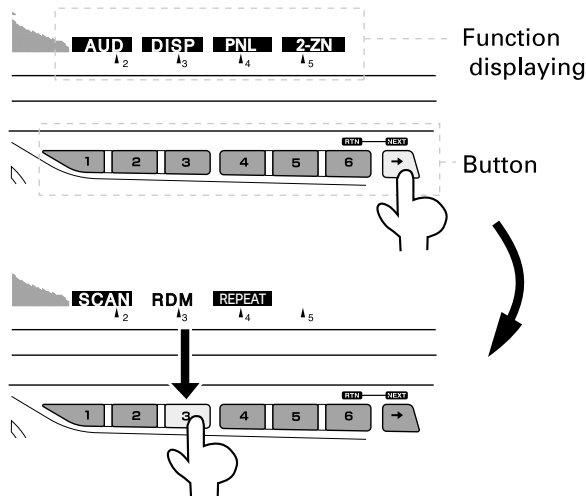

About CDs

Handling CDs

- Don't touch the recording surface of the CD.

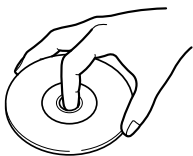

- CD-R and CD-RW are easier to damage than a normal music CD. Use a CD-R or a CD-RW after reading the caution items on the package etc.
- Don't stick tape etc. on the CD. Also, don't use a CD with tape stuck on it.

When using a new CD

If the CD center hole or outside rim has burrs, use it after removing them with a ball pen etc.

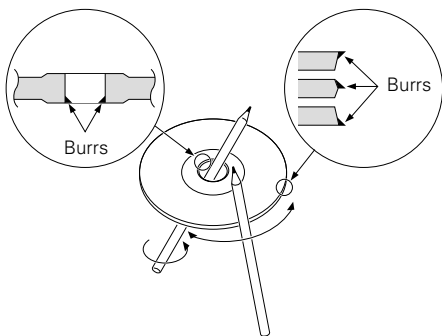

CD accessories

Don't use disc type accessories.

CD cleaning

Clean from the center of the disc and move outward.

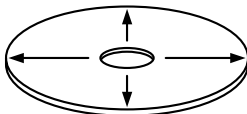

Removing CDs

When removing CDs from this unit pull them out horizontally.

CDs that can't be used

- CDs that aren't round can't be used.

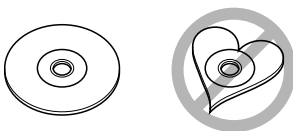

- CDs with coloring on the recording surface or that are dirty can't be used.
- This unit can only play the CDs with



It may not correctly play disks which do not have the mark.

- A CD-R or CD-RW that hasn't been finalized can't be played. (For the finalization process refer to your CD-R/CD-RW writing software, and your CD-R/CD-RW recorder instruction manual.)

General features

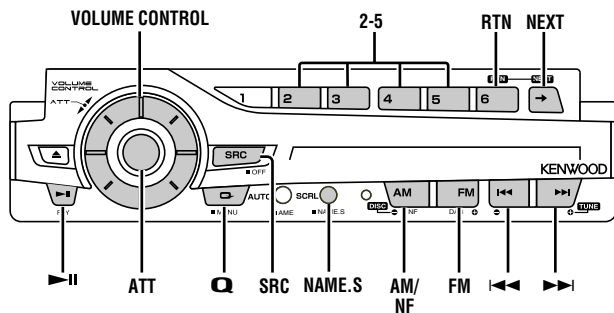

KDC-X969



KDC-X869/KDC-MP922

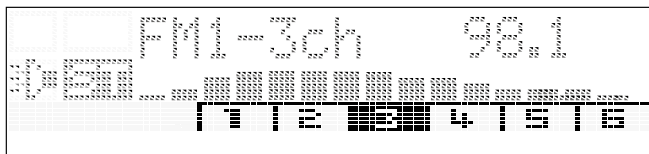

Power

Turning ON the Power

Turn the vehicle ignition ON.
The panel appears.

Turning OFF the Power

Turn the vehicle ignition OFF.
The panel hides.



Do not apply force to the panel during operation. It can cause damage.



When the power is ON, the <Security Code> (page 40) is displayed as "CODE ON" or "CODE OFF".

Selecting the Source

Press the [SRC] button.

Source required	Display
Sirius tuner (Optional accessory)	"SIRIUS"
Tuner	"TUNER"
CD	"CD"
External disc (Optional accessory)	"DISC CH"/"DISC"
Auxiliary input (Optional accessory)	"AUX1"
Internal auxiliary input	"AUX"
Standby (Illumination only mode)	"ALL OFF"

Volume

Increasing Volume

Turn the [VOLUME CONTROL] knob clockwise.

Decreasing Volume

Turn the [VOLUME CONTROL] knob counterclockwise.

Attenuator

Turning the volume down quickly.

Press the [ATT] button.

Each time the button is pressed the Attenuator turns ON or OFF. When it's ON, "ATT ON" is displayed.

Panel Position Setting

Setting the angle or back-forward position of the control panel.

1 Select the key function section

Press the [NEXT] button.

Repeatedly press the button until "PNL" is displayed above the [4] button.

2 Enter Panel Position Setting mode

Press the [4] ("PNL") button.

3 Select the item for adjustment

Press the desired [2] — [5] button.

Each time the button is pressed the items that can be adjusted switch as shown below.

Adjustment Item	Button	Display
The panel tilts upwards	[2]	"ANG-"
The panel tilts downwards	[3]	"ANG+"
The panel slides backward	[4]	"SLD-"
The panel slides forward	[5]	"SLD+"

4 Exit Panel Position Setting mode

Press the [RTN] button.



The control panel may be interfered with the shift lever or another part depending on the angles of the control panel. Set the angle to avoid any interference.



No sound is produced while the panel is operating.

General features

System Q

You can recall the best sound setting preset for different types of music.

1 Select the source to set

Press the [SRC] button.

2 Select the Sound type

Press the [Q] button.

Each time the button is pressed the sound setting switches.

Sound setting	Display
SRS WOW	"SRS WOW"
Flat	"FLAT"
User memory	"User Preset"
Rock	"ROCK"
Pops	"POPS"
Easy	"EASY"
Top 40	"TOP40"
Jazz	"JAZZ"



- User memory: The values set on the <Audio control> (page 12).
- Each setting value is changed with the <Speaker setting> (page 12).
First, select the speaker type with the Speaker setting.
- When <Dual Zone System> (page 26) is set to ON, the setting of SRS WOW is disabled.

Non-fading Output

Turning the Non-fading output ON or OFF.

Press the [NF] button for at least 1 second.

Each time the button is pressed Non-fading output switches ON or OFF.

When it's ON, "Non Fader ON" is displayed.

Speaker Setting

Fine-tuning so that the System Q value is optimal when setting the speaker type.

1 Enter Standby

Press the [SRC] button.

Select the "ALL OFF" display.

2 Enter Speaker Setting mode

Press the [Q] button.

"Speaker Setting" is displayed.

3 Select the Speaker type

Press the [2] — [5] button.

Each time the button is pressed the setting switches as shown below.

Speaker type	Button	Display
OFF	[2]	"OFF"
For 5 & 4 in. speaker	[3]	"5/4inch"
For 6 & 6x9 in. speaker	[4]	"6*9/6inch"
For the OEM speaker	[5]	"O.E.M."

4 Exit Speaker Setting mode

Press the [Q] button.

Audio Control

1 Select the source for adjustment

Press the [SRC] button.

2 Select the key function section

Press the [NEXT] button.

Repeatedly press the button until "AUD" is displayed above the [2] button.

Refer to <Notes on Multi-function Key System> (page 8).

3 Enter Audio Control mode

Press the [2] ("AUD") button.

4 Select the Adjustment item section

Press the [NEXT] button.

Repeatedly press the button until the desired Adjustment item is displayed above the [2] — [5] button.

1st section

Adjustment Item	Button	Display
Bass	[2]	"BASS"
Middle	[3]	"MID"
Treble	[4]	"TRE"
Balance & Fader	[5]	"BL/F"

2nd section

Adjustment Item	Button	Display
High Pass Filter	[2]	"HPF"
Low Pass Filter*	[3]	"LPF"
Loudness	[4]	"LOUD"
WOW	[5]	"WOW"

3rd section

Adjustment Item	Button	Display
Volume offset	[2]	"VOFF"
Non-Fading*	[3]	"N-F"

5 Select the Audio Control item for adjustment

Press the [2] — [5] button.

Each time the [2] — [5] button is pressed the adjustable audio items are switched among ranges of all stage section's tables on the following pages.

6 Adjust the Audio Control item

Press the [◀◀] or [▶▶] button.

Each time the button is pressed the setting switches as shown below.

7 Exit Audio Control mode

Press the [RTN] button.



- The loudness setting can also be adjusted by pressing the [4] button.
- WOW can be set when SRS WOW or User memory is selected at <System Q> (page 12).
- * This mode is available only when <Non-fading Output> (page 12) is ON.
- The Loudness can not be set when SRS WOW is selected at <System Q> (page 12).

General features

1st section

[2] button

Adjustment Item	Display	Range
Bass Center**	"Bass FRQ"	60/70/80/100 or 150 Hz Frequency
Bass level	"Bass"	-8 — +8
Bass Q Factor**	"Bass Q"	1.00/1.25/1.50/2.00
Bass Extend**	"Bass EXT"	ON/OFF

[3] button

Adjustment Item	Display	Range
Middle Center**	"MID FRQ"/"Middle FRQ"	0.5/1.0/1.5/2.0 kHz Frequency
Middle level	"MID"/"Middle"	-8 — +8
Middle Q Factor**	"MID Q"/"Middle Q"	1.0/2.0

[4] button

Adjustment Item	Display	Range
Treble Center**	"TRE FRQ"/"Treble FRQ"	10.0/12.5/15.0/17.5 kHz Frequency
Treble level	"TRE"/"Treble"	-8 — +8

[5] button

Adjustment Item	Display	Range
Balance	"Balance"	Left 15 — Right 15
Fader	"Fader"	Rear 15 — Front 15



- According to the Bass Q Factor setting value, the frequencies that can be set in Bass Center Frequency change as shown below.

Bass Q Factor	Bass Center Frequency
1.00/1.25/1.50	60/70/80/100
2.00	60/70/80/150

- When the bass extend is set to ON, low frequency response is extended by 20%.
- ** KDC-X969/ KDC-X869 only

2nd section

[2] button

Adjustment Item	Display	Range
Front High Pass Filter	"HPF Front"	Through/40/60/80/100/120/150/180/220 Hz
Rear High Pass Filter	"HPF Rear"	Through/40/60/80/100/120/150/180/220 Hz

[3] button

Adjustment Item	Display	Range
Non-Fading Low Pass Filter	"LPF NF"	50/80/120/Through Hz

[4] button

Adjustment Item	Display	Range
Loudness	"Loudness"	ON/OFF

[5] button

Adjustment Item	Display	Range
WOW	"SRS WOW"	Low/High/OFF
TruBass	"SRS TruBass"	ON/OFF
FOCUS	"FOCUS"	Low/High/OFF
SRS	"SRS"	ON/OFF



- Loudness: Compensating for low and high tones during low volume.
- WOW: TruBass, FOCUS and SRS are all set to values shown below.

WOW	TruBass	FOCUS	SRS
High	ON	High	ON
Low	ON	Low	ON
OFF	OFF	OFF	OFF

- TruBass: Assisting the playback for the super bass sound.
- FOCUS: Adjusts the sound image by changing the vertical position of the speakers virtually.
- SRS: Making a natural 3D sound field.
- SRS cannot be set in tuner source.

3rd section**[2] button**

Adjustment Item	Display	Range
Volume offset	"Volume Offset"	-8 — ±0

[3] button

Adjustment Item	Display	Range
Non-Fading level	"NF Level"	-15 — +15
Non-Fading Phase	"NF Phase"	Normal (0°)/Reverse (180°)



- Volume offset: Each source's volume can be set as a difference from the basic volume.

General features

Display Mode Switching

Switching the display mode.

1 Select the key function section

Press the [NEXT] button.

Repeatedly press the button until "DISP" is displayed above the [3] button.

Refer to <Notes on Multi-function Key System> (page 8).

2 Enter display control mode

Press the [3] ("DISP") button.

3 Select the display mode

Press the [2] ("MODE") button.

Each time the button is pressed the display mode switches as shown below.

KDC-X969

Display Mode Display

Display Mode	Display
"Display:A"	
"Display:B"	
"Display:C"	

KDC-X869/MP922

Display Mode Display

Display Mode	Display
"Display Type A"	
"Display Type B"	
"Display Type C"	

4 Exit display control mode

Press the [RTN] button.



- If the [1] — [6] button or the [NEXT] button is pressed while "Display Type C" is selected, "Display Type C" is temporarily switched to "Display Type B" and the function item is displayed. After the operation is completed, "Display Type B" is returned to "Display Type C".
- If <Dual Zone System> (page 26) is turned ON while "Display Type B" or "Display Type C" is selected, the display is automatically switched to "Display Type A".

Right Side Graphic Display Switching

Switching the Right side graphic Display.

1 Select the key function section

Press the [NEXT] button.

Repeatedly press the button until "DISP" is displayed above the [3] button.

Refer to <Notes on Multi-function Key System> (page 8).

2 Enter display control mode

Press the [3] ("DISP") button.

3 Select the Right side graphic display

Press the [3] ("SA") button.

Each time the button is pressed the right side graphic display switches as shown below.

Right side graphic display

Demonstration

Movie 1

Movie 2

Movie 3

Downloaded movie

Spectrum analyzer 1

Spectrum analyzer 2

Spectrum analyzer 3

Spectrum analyzer 4

Spectrum analyzer 5

Wallpaper

4 Exit display control mode

Press the [RTN] button.



- The setting of this function is available while "Display Type B" or "Display Type C" is selected for the Display mode.
- A downloaded movie can be selected when it has been downloaded into this unit.
Refer to <Picture downloading> (page 46).
- Wallpapers can be changed.
This unit comes with 3 types of wallpaper registered.
A downloaded wallpaper is added to the place after the last original wallpaper of this unit.
Refer to <Wallpaper selecting> (page 18).

General features

Function of the KDC-X969

Wallpaper selecting

Select a wallpaper to display when Display Type is set to "Display Type B" or "Display Type C".

1 Select the wallpaper display

Refer to <Right Side Graphic Display Switching> (page 17).

2 Select the wallpaper

Display the wallpapers one after another and select one

1 Turn the wallpaper scan ON

Press the [▶||] button.

Each time the button is pressed the Wallpaper scan is turned ON and OFF.

When it's ON, "SCAN" is displayed.

When it's ON, each wallpaper is displayed every several seconds.

2 At the wallpaper you want to display

Press the [▶||] button.

Select wallpaper manually

1 Turn the wallpaper scan OFF.

Press the [▶||] button.

Each time the button is pressed the Wallpaper scan is turned ON and OFF.

2 Select the wallpaper.

Press the [◀◀] or [▶▶] button.

Each time the button is pressed the wallpaper changes.

3 Exit Display Control mode

Press the [RTN] button.

Function of the KDC-X869/KDC-MP922

Graphic part/ Spectrum Analyzer & Text Display Switching

Switching the graphic Display/ Spectrum analyzer & Text display.

1 Select the key function section

Press the [NEXT] button.

Repeatedly press the button until "DISP" is displayed above the [3] button.

Refer to <Notes on Multi-function Key System> (page 8).

2 Enter display control mode

Press the [3] ("DISP") button.

3 Select the graphic display

Press the [3] ("SA") button.

Refer to the table described later for setting items.

Select the Spectrum analyzer & Text display part display

(Only when Display Type is "Display Type C")

Press the [◀◀] or [▶▶] button.

Refer to the table described later for setting items.

4 Exit display control mode

Press the [RTN] button.



The setting of this function is available while "Display Type B" or "Display Type C" is selected for the Display mode.

Graphic display

Demonstration

Spectrum analyzer 1

Spectrum analyzer 2

Spectrum analyzer 3

Spectrum analyzer 4

Spectrum analyzer 5

Graphic

Spectrum analyzer & Text display part

In Tuner source

Information	Display
Spectrum Analyzer & Clock	"S+CLK"
Spectrum Analyzer	"S/ANA"
Date	"DATE"
Radio text, Program Service name or Frequency	"R-TXT"
Station name, Program Service name or Frequency	"SNPS"

In CD & External disc source

Information	Display
Spectrum Analyzer & Clock	"S+CLK"
Spectrum Analyzer	"S/ANA"
Date	"DATE"
Disc title	"D-TTL"
Track title	"T-TTL"
Disc name	"DNPS"

In MP3 source

Information	Display
Spectrum Analyzer & Clock	"S+CLK"
Spectrum Analyzer	"S/ANA"
Date	"DATE"
Song title & Artist name	"TITLE"
Album name & Artist name	"ALBUM"
Folder name	"FOLDR"
File name	"FILE"
Disc name	"DNPS"

In Auxiliary input source

Information	Display
Spectrum Analyzer & Clock	"S+CLK"
Spectrum Analyzer	"S/ANA"
Date	"DATE"

In Sirius tuner source

Information	Display
Spectrum Analyzer & Clock	"S+CLK"
Spectrum Analyzer	"S/ANA"
Date	"DATE"
Channel Name	"CH"
Song Title	"SONG"
Artist Name	"ARTST"
Composer name	"CMPSR"
Label	"LABEL"
Comment	"COMNT"



- If the Disc title, Track title, Song title & Artist name, or Album name & Artist name is selected when the disc which does not have Disc title, Track title, Song title, Album name, or Artist name is played, track number and play time are displayed.
- If the text for the Sirius tuner source, including Channel name, etc. is selected when the channel which does not have text for the Sirius tuner source, including Channel name, etc. is played, band & channel number is displayed.

General features

Function of the KDC-X969

Left Side Graphic Display Switching

Switching the Left side graphic Display.

1 Select the key function section

Press the [NEXT] button.

Repeatedly press the button until "DISP" is displayed above the [3] button.

Refer to <Notes on Multi-function Key System> (page 8).

2 Enter display control mode

Press the [3] ("DISP") button.

3 Switch the Left graphic part

Press the [4] ("GRPH") button.

Each time the button is pressed the Left side graphic part switches as shown below.

Left side graphic part

Source graphic

Spectrum analyzer 1

Spectrum analyzer 2

Spectrum analyzer 3

Spectrum analyzer 4

Spectrum analyzer 5

Spectrum analyzer 6

Spectrum analyzer 7

Blank

4 Exit display control mode

Press the [RTN] button.



If <Dual Zone System> (page 26) is turned ON while the spectrum analyzer is displayed, the left side graphic display automatically displays the source graphic.

Text Display Switching

Switching the text display.

1 Select the key function section

Press the [NEXT] button.

Repeatedly press the button until "DISP" is displayed above the [3] button.

Refer to <Notes on Multi-function Key System> (page 8).

2 Enter display control mode

Press the [3] ("DISP") button.

3 Enter text select mode

Press the [3] ("TEXT") button.

4 Select the text in the upper text display part

Press the [FM] or [AM] button.

Select the text in the lower text display part

Press the [◀◀] or [▶▶] button.

Refer to the table described later for setting items.

5 Exit Display Control mode

Press the [RTN] button.



- The setting of this function is available while "Display Type A" is selected for the Display mode.
- Upper text display part cannot display the same information as Lower text display part.
- The Album name cannot be displayed during WMA play.

The text display in the Upper text display part

In Tuner source

Information	Display
Station name, Program Service name or Frequency	"BAND+ch+SNPS"
Radio text, Program Service name or Frequency	"R-TEXT"
Frequency	"BAND+ch+FREQ"

In CD & External disc source

Information	Display
Disc title	"DISC-TITLE"
Track title	"TRACK-TITLE"
Track number & Play time	"P-Time"
Disc name	"DNPS"

In MP3/WMA source

Information	Display
Song title & Artist name	"TITLE/ARTIST"
Album name & Artist name	"ALBUM/ARTIST"
Folder name	"FOLDER NAME"
File name	"FILE NAME"
Track number & Play time	"P-Time"
Disc name	"DNPS"

In Sirius tuner source

Information	Display
Channel Name	"Channel Name"
Song Title	"Song Title"
Artist Name	"Artist Name"
Composer name	"Composer Name"
Category Name	"Category Name"
Label	"Label Name"
Comment	"Comment"
Band & Channel Number	"Channel Number"



- Auxiliary input name is displayed for the Auxiliary input source.
- If the Disc title, Track title, Song title & Artist name, or Album name & Artist name is selected when the disc which does not have Disc title, Track title, Song title, Album name, or Artist name is played, track number and play time are displayed.
- If the text for the Sirius tuner source, including Channel name, etc. is selected when the channel which does not have text for the Sirius tuner source, including Channel name, etc. is played, band & channel number is displayed.

General features

The text display in the Lower text display part

In Tuner source

Information	Display
Indicator & Clock (KDC-X969 only)	"CLOCK"
Spectrum Analyzer & Clock	"S/ANA+CLOCK"
Spectrum Analyzer	"S/ANA"
Date	"DATE"
Radio text or Spectrum Analyzer & Clock	"R-TEXT"

In CD & External disc source

Information	Display
Indicator & Clock (KDC-X969 only)	"CLOCK"
Spectrum Analyzer & Clock	"S/ANA+CLOCK"
Spectrum Analyzer	"S/ANA"
Date	"DATE"
Disc Title	"DISC-TITLE"
Track Title	"TRACK-TITLE"
Disc name	"DNPS"

In MP3/WMA source

Information	Display
Indicator & Clock (KDC-X969 only)	"CLOCK"
Spectrum Analyzer & Clock	"S/ANA+CLOCK"
Spectrum Analyzer	"S/ANA"
Date	"DATE"
Song title & Artist name	"TITLE/ARTIST"
Album name & Artist name	"ALBUM/ARTIST"
Folder name	"FOLDER NAME"
File name	"FILE NAME"
Disc name	"DNPS"

In Auxiliary input source

Information	Display
Indicator & Clock (KDC-X969 only)	"CLOCK"
Spectrum Analyzer & Clock	"S/ANA+CLOCK"
Spectrum Analyzer	"S/ANA"
Date	"DATE"

In Sirius tuner source

Information	Display
Indicator & Clock (KDC-X969 only)	"CLOCK"
Spectrum Analyzer & Clock	"S/ANA+CLOCK"
Spectrum Analyzer	"S/ANA"
Date	"DATE"
Channel Name	"Channel Name"
Song Title	"Song Title"
Artist Name	"Artist Name"
Composer name	"Composer Name"
Label	"Label Name"
Comment	"Comment"



- If <Dual Zone System> (page 26) is turned ON while the spectrum analyzer is displayed, the spectrum analyzer is not displayed.
- If the Disc title, Track title, Song title & Artist name, or Album name & Artist name is selected when the disc which does not have Disc title, Track title, Song title, Album name, or Artist name is played, Spectrum Analyzer & Clock are displayed.
- If the text for the Sirius tuner source, including Channel name, etc. is selected when the channel which does not have text for the Sirius tuner source, including Channel name, etc. is played, Spectrum Analyzer & Clock are displayed.

Switching the Standby Display

Switching the information displayed in Standby.

1 Enter Standby

Press the [SRC] button.

Select the "ALL OFF" display.



The setting of this function is available while "Display Type A" is selected for the Display mode.

2 Enter display control mode

Press the [3] ("DISP") button.

3 Enter text select mode

Press the [3] ("TEXT") button.

4 Switch the display

Press the [◀▶] or [▶▶] button.

Each time the button is pressed the display switches.

KDC-X969

Information	Display
Standby display & Clock	"ALL OFF" & "CLOCK"
Standby display	"ALL OFF"
Date & Clock	"DATE" & "CLOCK"

KDC-X869/MP922

Information	Display
Date & Clock	"DATE" & "CLOCK"
Standby display	"ALL OFF"



KDC-X869/MP922: While "Display Type C" is selected for the Display mode the date is only displayed.

5 Exit Display Control mode

Press the [RTN] button.

Font Color Select

Selecting the display font color.

1 Select the key function section

Press the [NEXT] button.

Repeatedly press the button until "DISP" is displayed above the [3] button.

Refer to <Notes on Multi-function Key System> (page 8).

2 Enter display control mode

Press the [3] ("DISP") button.

3 Switch the Font color

Press the [4] ("CLR") button.

Repeatedly press the button, nine kinds of Font colors are shown in turn.

4 Exit display control mode

Press the [RTN] button.

General features

Station/Disc Naming (SNPS/DNPS)

Attaching a title to a Station or CD.

1 Receive/play the station/disc you want to attach a title to



A title can't be attached to MD.

2 Enter name set mode

Press the [NAME.S] button for at least 2 seconds.

"Name Set" is displayed.

3 Move the cursor to the enter character position

Press the [◀◀] or [▶▶] button.

4 Select the character type

Press the [2] — [4] button.

Each time the button is pressed the character type switches as shown below.

Character type	Button
Alphabet (Upper case/ Lower case)	[2] ("A • a")
Numbers and symbols	[3] ("1")
Special characters (Accent characters)	[4] ("CHAR")

5 Select the characters

Press the [FM] or [AM] button.



Characters can be entered by using a remote with a number buttons.

Example: If "DANCE" is entered.

Character	Button	Times pressed
"D"	[3]	1
"A"	[2]	1
"N"	[6]	2
"C"	[2]	3
"E"	[3]	2

6 Repeat steps 3 through 5 and enter the name.

7 Exit name set mode

Press the [NAME.S] button.



- When operation stops for 10 seconds the name at that time is registered, and Name Set mode closes.
- Memory numbers
 - FM: 32 stations
 - AM: 16 stations
 - Internal CD player: 30 discs
 - External CD changer/ player: Varies according to the CD changer/ player. Refer to the CD changer/ player manual.
- The title of station/CD can be changed by the same operation used to name it.

Auxiliary Input Display Setting

Selecting the display when this device is switched to Auxiliary input source.

1 Select Auxiliary input source

Press the [SRC] button.

Select the "AUX"/"AUX1" display.

2 Enter Auxiliary input display setting mode

Press the [NAME.S] button for at least 2 seconds.

The presently selected AUX Name is blinks.

3 Select the Auxiliary input display

Press the [◀◀] or [▶▶] button.

Each time the button is pressed it switches through the below displays.

- "AUX"/"AUX1"
- "TV"
- "VIDEO"
- "GAME"
- "PORTABLE"
- "DVD"

4 Exit Auxiliary input display setting mode

Press the [NAME.S] button.

-  When operation stops for 10 seconds, the name at that time is selected, and Auxiliary input display setting mode closes.

Theft Deterrent Panel

The Backpanel of the unit can be detached and taken with you, helping to deter theft.

Removing the Backpanel

- 1 Turn the ignition OFF or press the [SRC] button for at least 1 second.

Turn OFF the power, and the control panel becomes horizontal.

-  After the set time passes in <OFF Wait Time Setting> (page 43), the panel is closed.

- 2 Remove the Backpanel forward.

When <DSI (Disabled System Indicator)> (page 42) is set to ON, DSI blinks.

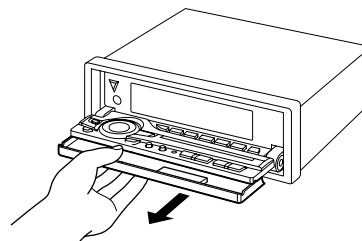

-  • The back panel is a precision piece of equipment and can be damaged by shocks or jolts. For that reason, keep the back panel in its special storage case while detached.
- Do not expose the Backpanel or its storage case to direct sunlight or excessive heat or humidity. Also avoid places with too much dust or the possibility of water splashing.

Reattaching the Backpanel

- 1 Set the Backpanel to the panel bracket.
- 2 Hold down on the Backpanel until it is locked.

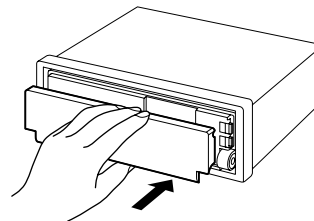

General features

Hiding the Control Panel

Prevents tampering with the unit while your car is being serviced etc.

Hiding the control panel

Press the [SRC] button for at least 1 second.
When the time set in <OFF Wait Time Setting> (page 43) lapses, the panel is hidden and the power turns OFF.

Showing the control panel

Press the left part at the lower side of the panel.

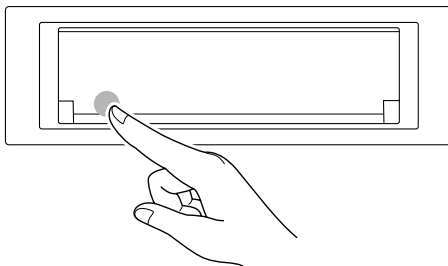

The panel is opened to enable the operation.

Dual Zone System <In Sirius Tuner, External disc, or Auxiliary input source>

Makes the sound different for the front channel and rear channel.

1 Select the source

Press the [SRC] button.
Select the source sound to be output from the Dual zone channel.

2 Select the key function section

Press the [NEXT] button.
Repeatedly press the button until "2-ZN" is displayed above the [5] button.
Refer to <Notes on Multi-function Key System> (page 8).

3 Enter the Dual Zone System Control mode

Press the [5] ("2-ZN") button.

4 Select the item for adjustment

Press the desired [2] — [3] button.
Each time the button is pressed the items that can be adjusted switch as shown below.

Adjustment Item	Button	Display	Range
Dual Zone System	[2]	"ON"/"OFF"	ON/OFF
Dual Zone System Front & Rear	[3]	"F ↔ R"	Front/Rear



Dual Zone System Rear: The sound of the source selected with step 1 is outputted from rear, and the sound of the source selected with step 6 is outputted from front.

Dual Zone System Front: The sound of the source selected with step 1 is outputted from front, and the sound of the source selected with step 6 is outputted from rear.

5 Exit the Dual Zone System Control mode

Press the [RTN] button.

6 Select the source

Press the [SRC] button.
Select the source sound to be output from the other source channel.



- The Dual Zone System can be used with the sources shown below.
 - Internal auxiliary input
 - KCA-S210A
 - CA-C1AX
 - External disc changer/ player
 - Sirius satellite radio tuner
- While Dual Zone System is ON, the setting of Dual Zone System Front or Rear is disabled. Set Dual Zone System Front or Rear first, and then set the Dual Zone System to ON.
- When the Dual Zone System is ON, there is no Dual zone channel audio control or other effect.
- When you use the Dual Zone System by selecting the optional accessory source for the output of the Dual zone channel, you cannot select another optional accessory source as the source for the Internal source channel.
- When you set the Dual zone system to ON while the non-fading preout is switched ON, the sound of the non-fading preout isn't output.
- When "SRS WOW" is selected at <System Q> (page 12), the Dual Zone System cannot be turned on and off. Also set all the <Audio Control> (page 12) WOW items to OFF. The Dual Zone System cannot be turned on and off if even one of the items is set to ON.

Tuner features

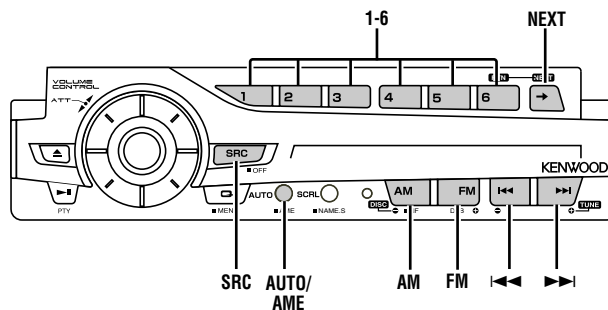

KDC-X969

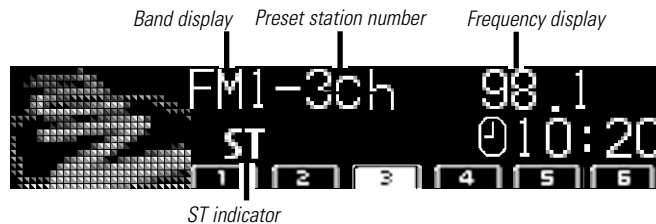

KDC-X869/KDC-MP922

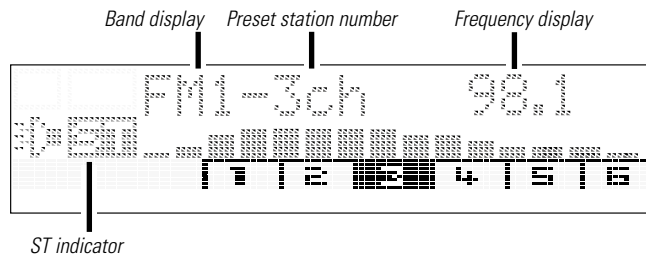

Tuner features

Tuning Mode

Choose the tuning mode.

Press the [AUTO] button.

Each time the button is pressed the Tuning mode switches as shown below.

Tuning mode	Display	Operation
Auto seek	"Auto1"	Automatic search for a station.
Preset station seek	"Auto2"	Search in order of the stations in the Preset memory.
Manual	"Manual"	Normal manual tuning control.

Tuning

Selecting the station.

1 Select tuner source

Press the [SRC] button.
Select the "TUNER" display.

2 Select the band

Press the [FM] or [AM] button.
Each time the [FM] button is pressed it switches between the FM1, FM2, and FM3 bands.

3 Tune up or down band

Press the [◀◀] or [▶▶] button.



During reception of stereo stations the "ST" indicator is ON.

Direct Access Tuning (Function of remote)

Entering the frequency and tuning.

1 Select the band

Press the [FM] or [AM] button.

2 Enter Direct Access Tuning mode

Press the [DIRECT] button on the remote.
"----" is displayed.

3 Enter the frequency

Press the number buttons on the remote.
Example:

Desired frequency	Press button
92.1 MHz (FM)	[0], [9], [2], [1]
810 kHz (AM)	[0], [8], [1], [0]

Canceling Direct Access Tuning

Press the [DIRECT] button on the remote.

Station Preset Memory

Putting the station in the memory.

1 Select the band

Press the [FM] or [AM] button.

2 Select the frequency to put in the memory

Press the [◀◀] or [▶▶] button.

3 Select the key function section

Press the [NEXT] button.
Repeatedly press the button until "[1]" — "[6]" are displayed above the [1] — [6] buttons.
Refer to <Notes on Multi-function Key System> (page 8).

4 Put the frequency in the memory

Press the desired [1] — [6] button for at least 2 seconds.

The preset number display blinks 1 time.

On each band, 1 station can be put in the memory on each [1] — [6] button.

Auto Memory Entry

Putting stations with good reception in the memory automatically.

1 Select the band for Auto Memory Entry

Press the [FM] or [AM] button.

2 Open Auto Memory Entry

Press the [AME] button for at least 2 seconds.

When 6 stations that can be received are put in the memory Auto Memory Entry closes.

Preset Tuning

Calling up the stations in the memory.

1 Select the band

Press the [FM] or [AM] button.

2 Select the key function section

Press the [NEXT] button.

Repeatedly press the button until "[1]" — "[6]" are displayed above the [1] — [6] buttons.

Refer to <Notes on Multi-function Key System> (page 8).

3 Call up the station

Press the desired [1] — [6] button.

SNPP (Station Name Preset Play) (Function of Remote)

Selecting the stations to display SNPS.

1 Enter SNPP mode

Press the [DNPP] button on the remote.

When "SNPP" is displayed, SNPS displays the FM1, FM2, FM3 and AM bands in order.



If the station has no name, the frequency or program service name is displayed instead.

Changing the display order

Press the [◀◀] or [▶▶] button.

Changing the displayed band

Press the [FM] or [AM] button.

2 If the station you want is displayed

Press the [OK] button on the remote.

The displayed SNPS station is received.

Canceling the SNPP mode

Press the [DNPP] button on the remote.

RDS features

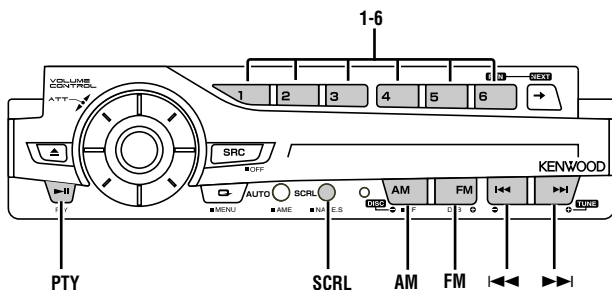

KDC-X969

Program Service name



Radio text

KDC-X869/KDC-MP922

Program Service name

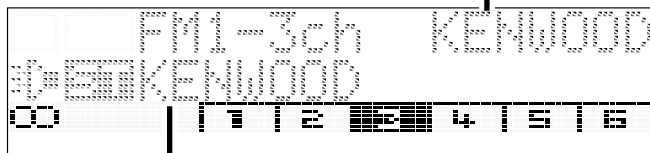

Radio text

Radio Text Scroll

Scrolling the displayed radio text.

Press the [SCRL] button.

PTY (Program Type)

Selecting the Program Type and searching for a station.

1 Enter PTY mode

Press the [PTY] button.

"PTY Select" is displayed.



This function can't be used during a traffic bulletin or AM reception.

2 Select the Program Type

Press the [FM] or [AM] button.

No.	Program Type	Display
1.	Speech	"All Speech"
2.	Music	"All Music"
3.	News	"News"
4.	Information	"Information"
5.	Sports	"Sports"
6.	Talk	"Talk"
7.	Rock	"Rock"
8.	Classic Rock	"Classic Rock"
9.	Adult Hits	"Adult Hits"
10.	Soft Rock	"Soft Rock"
11.	Top 40	"Top 40"
12.	Country	"Country"
13.	Oldies	"Oldies"
14.	Soft	"Soft"
15.	Nostalgia	"Nostalgia"

16.	Jazz	"Jazz"
17.	Classical	"Classical"
18.	R & B	"Rhythm & Blues"
19.	Soft R & B	"Soft R & B"
20.	Language	"Foreign Language"
21.	Religious Music	"Religious Music"
22.	Religious Talk	"Religious Talk"
23.	Personality	"Personality"
24.	Public	"Public"
25.	College	"College"
26.	Weather	"Weather"



• Speech and Music include the Program type below.

Music: No.7 — 19, 21

Speech: No.3 — 6, 20, 22 — 26

• The Program Type can be put in the [1] — [6] button memory and called up quickly. Refer to the <Program Type preset> (page 31).

3 Search for the selected Program Type station

Press the [◀◀] or [▶▶] button.

When you want to search for other stations press the [◀◀] or [▶▶] button again.



When the selected Program Type isn't found, "No PTY" is displayed. Select another Program Type.

4 Exit PTY mode

Press the [PTY] button.

3 Register the Program Type

Press the [SCRL] button for at least 2 seconds.

Confirming the Program Type

Press the [SCRL] button.

The Program Type is displayed for 5 seconds.

4 Exit PTY mode

Press the [PTY] button.

Program Type preset

Putting the Program Type in the Preset button memory and calling it up quickly.

Presetting the Program Type

1 Select the Program Type to preset

Refer to <PTY (Program Type)> (page 30).

2 Preset the Program Type

Press the desired [1] — [6] button for at least 2 seconds.

Calling up the preset Program Type

1 Enter PTY mode

Refer to <PTY (Program Type)> (page 30).

2 Call up the Program Type

Press the desired [1] — [6] button.

Registration of a station as a PTY

Registering a Program Type for stations with no PTY data.

1 Receive the station you want to register

2 Select the Program Type to register

Refer to <PTY (Program Type)> (page 30).

CD/MP3/WMA/External disc control features

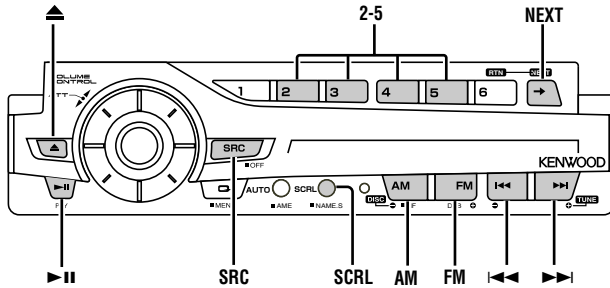

KDC-X969

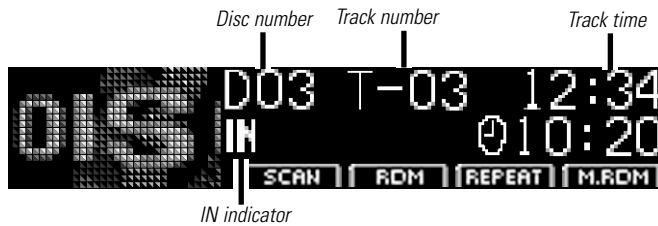

KDC-X869/KDC-MP922

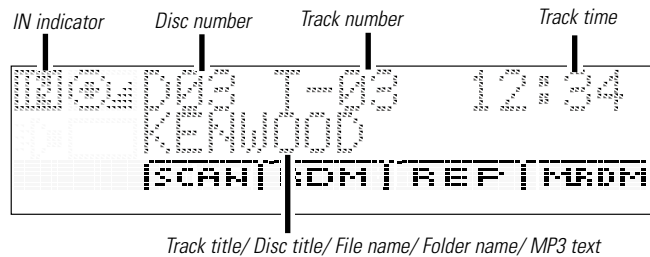

Track title/ Disc title/ File name/ Folder name/ MP3 text

Playing CD & MP3/WMA

When there is no disc inserted

- 1 **Open the panel to insert disc**
Press the [▲] button.

- 2 **Insert a disc.**

⚠ When the faceplate has been slid open, it might interfere with the shift lever or something else. If this happens, pay attention to safety and move the shift lever or take an appropriate action, then operate the unit.



- The sound will be temporarily muted while the faceplate is moving.
- The model that can play WMA is shown below.
KDC-X969
- When a disc is inserted the "IN" indicator is ON.

When a disc is inserted

- Press the [SRC] button.
Select the "CD" display.

Pause and play

- Press the [▶||] button.
Each time the button is pressed the song pauses or plays.

Eject the disc

- 1 **Eject the disc**
Press the [▲] button.

- 2 **Return the panel to the original position**
Press the [▲] button.



3 in. (8cm) disc can't be played. Using an adapter and inserting them into this unit can cause damage.



The MP3/WMA media that this unit can play are CD-ROM, CD-R, and CD-RW. The medium formats must be ISO 9660 Level 1, Level 2, Joliet, or Romeo. The methods and precautions to be followed for writing MP3/WMA data are covered in <Notes on playing MP3/WMA> (page 6). Check that section before creating your MP3/WMA media.

Playing External Disc

Playing discs set in the optional accessory disc player connected to this unit.

Press the [SRC] button.

Select the display for the disc player you want.

Display examples:

Display	Disc player
"CD2"	CD player
"DISC CH"/"DISC"	CD changer/ MD changer

Pause and play

Press the [▶||] button.

Each time the button is pressed it pauses and plays.



The functions that can be used and the information that can be displayed will differ depending on the external disc players being connected.

Fast Forwarding and Reversing

Fast Forwarding

Hold down on the [▶▶] button.

Release your finger to play the disc at that point.

Reversing

Hold down on the [◀◀] button.

Release your finger to play the disc at that point.

Track/File Search

Searching for a song on the disc or in the MP3/WMA folder.

Press the [◀◀] or [▶▶] button.

Disc/ Folder Search

(Disc Search: Function of disc changer)
(Folder Search: Function of MP3/WMA)

Selecting the disc set in the Disc changer or the folder recorded on the MP3/WMA media.

Press the [FM] or [AM] button.

Direct Track/File Search (Function of remote)

(Direct File Search: Function of MP3/WMA)

Doing Track/File Search by entering the track/file number.

1 Enter the track/file number

Press the number buttons on the remote.

2 Do Track/File Search

Press the [◀◀] or [▶▶] button.

Canceling Direct Track/File Search

Press the [▶||] button.

CD/MP3/WMA/External disc control features

Direct Disc Search (Function of disc changers with remote)

Doing Disc Search by entering the disc number.

1 Enter the disc number

Press the number buttons on the remote.

2 Do Disc Search

Press the [DISC+] or [DISC-] button.

Canceling Direct Disc Search

Press the [▶||] button.



Input "0" to select disc 10.

Track/File/Disc/Folder Repeat

Replaying the song, disc in the Disc changer or MP3/WMA folder you're listening to.

1 Select the key function section

Press the [NEXT] button.

Repeatedly press the button until "REPEAT"/"REP" is displayed above the [4] button.

Refer to <Notes on Multi-function Key System> (page 8).

2 Turn ON/OFF the Repeat Play

Press the [4] ("REPEAT"/"REP") button.

Each time the button is pressed the Repeat Play switches as shown below.

In CD & External disc source

Repeat play	Display
Track Repeat	"Repeat ON"/ "Track Repeat ON"
Disc Repeat (In Disc Changer)	"Disc Repeat ON"
OFF	"Repeat OFF"

In MP3/WMA source

Repeat play	Display
File Repeat	"File Repeat ON"
Folder Repeat	"Folder Repeat ON"
OFF	"Repeat OFF"

Scan Play

Playing the first part of each song on the disc or MP3/WMA folder you are listening to and searching for the song you want to listen to.

1 Select the key function section

Press the [NEXT] button.

Repeat to press the button until "SCAN" is displayed above the [2] button.

2 Start Scan Play

Press the [2] ("SCAN") button.

"Scan ON" is displayed.

3 Release it when the song you want to listen to is played

Press the [2] button.

Random Play

Play all the songs on the disc or MP3/WMA folder in random order.

1 Select the key function section

Press the [NEXT] button.

Repeatedly press the button until "RDM" is displayed above the [3] button.

2 Turn ON/OFF the Random Play

Press the [3] ("RDM") button.

Each time the button is pressed Random Play turns ON or OFF. When it's ON, "Random ON" is displayed.



When the [▶▶] button is pressed, the next song select starts.

Magazine Random Play

(Function of disc changer)

Play the songs on all the discs in the disc changer in random order.

1 Select the key function section

Press the [NEXT] button.

Repeatedly press the button until "M.RDM" is displayed above the [5] button.

2 Turning ON/OFF the Magazine Random Play

Press the [5] ("M.RDM") button.

Each time the button is pressed the Magazine Random Play turns ON or OFF.

When it's ON, "M.Random ON" is displayed.



When the [▶▶] button is pressed, the next song select starts.

Text/Title Scroll

Scrolling the displayed CD text, MP3/WMA text, or MD title.

Press the [SCRL] button.

DNPP (Disc Name Preset Play)

(Function of disc changers with remote)

Selecting the CD displayed in the DNPS of the CDs set in the Disc changer.

1 Enter DNPP mode

Press the [DNPP] button on the remote.

When "DNPP" is displayed the DNPS display in order.

Forward / Reverse display

Press the [DISC-] or [DISC+] button.

2 When the disc you want is displayed

Press the [OK] button on the remote.

The disc being displayed is played.

Canceling the DNPP mode

Press the [DNPP] button on the remote.

CD/MP3/WMA/External disc control features

Folder Select (Function of MP3/WMA)

Quickly selecting the folder you want to listen to.

1 Select the key function section

Press the [NEXT] button.

Repeatedly press the button until "FSEL" is displayed above the [5] button.

Refer to <Notes on Multi-function Key System> (page 8).

2 Enter Folder Select mode

Press the [5] ("FSEL") button.

"Select Mode" is displayed.

During Select mode the folder information is displayed as shown below.

KDC-X869

<Folder name display>

Displays the current folder name.



<Folder number display>

Displays the number in the folder belonging to the currently selected folder.

KDC-X869/MP922

<Folder name display>

Displays the current folder name.

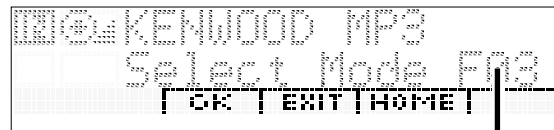

<Folder number display>

Displays the number in the folder belonging to the currently selected folder.

3 Select the folder level

Press the [FM] or [AM] button.

With the [FM] button you move 1 level down and with the [AM] button 1 level up.

Selecting a folder in the same level

Press the [◀◀] or [▶▶] button.

With the [◀◀] button you move to the previous folder, and with the [▶▶] button to the next folder.

Returning to the top level

Press the [4] ("HOME") button.

Scrolling the folder name display

Press the [SCRL] button.

4 Decide the folder to play

Press the [2] ("OK") button.

The Folder Select mode releases, and the MP3/WMA in the folder being displayed is played.



The methods for moving to other folders in the folder select mode are different from those in the folder search mode.

See <Notes on playing MP3/WMA> (page 6) for details.

Canceling the Folder Select mode

Press the [3] ("EXIT") button.

Sirius tuner control features

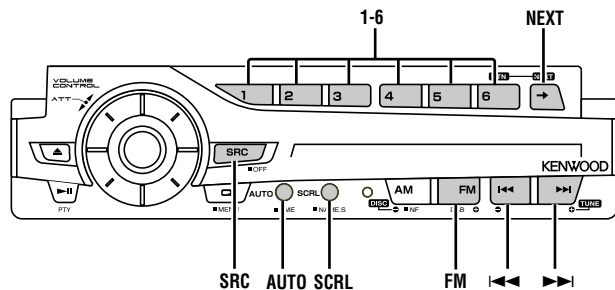

KDC-X969



KDC-X869/KDC-MP922

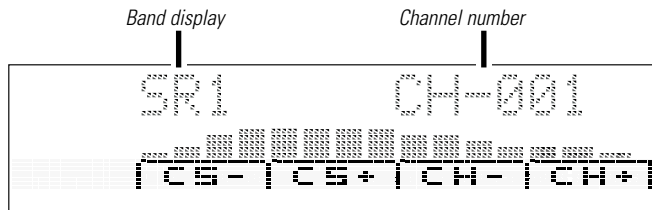

Select Sirius Satellite Radio Mode

Selecting the Sirius Satellite Radio Tuner (optional accessory) connected to this unit.

Selecting Sirius Mode

Press the [SRC] button.

Select the "SIRIUS" display.



- You need to subscribe to SIRIUS to receive the service by Sirius Satellite Radio. Consult SIRIUS if "CALL 888-539 SIRIUS TO SUBSCRIBE" appears.
- It may take a little time to start receiving after you selected the SIRIUS source.
- If the signal receiving fails, "Acquiring Signal" appears.

Switching Seek Mode

Sets the seeking mode.

Press the [AUTO] button.

Each time the button is pressed the Seek mode switches as shown below.

Display	Operation
"Seek Mode Channel"	Normal manual seeking control.
"Seek Mode Preset"	Search in order of the channels in the Preset memory.

Sirius tuner control features

Channel/Category Search

Selecting the channel and category you want to receive.

1 Select the key function section

Press the [NEXT] button.

Repeatedly press the button until "CH+"/ "CH-" / "CS+" / "CS-" is displayed above the [2] — [5] button.

2 Select the item for adjustment

Press the desired [2] — [5] button.

Each time the button is pressed the items that can be adjusted switch as shown below.

Adjustment Item	Button	Display
Search down in category	[2]	"CS-"
Search up in category	[3]	"CS+"
Search down for channel in selected category	[4]	"CH-"
Search up for channel in selected category	[5]	"CH+"



You cannot operate this unit until all the Category information is acquired.

Direct Access Tuning (Function of remote)

Entering the channel and tuning.

1 Enter Direct Access Tuning mode

Press the [DIRECT] button on the remote.

2 Enter the channel

Press the number buttons.

3 Do Channel Search

Press the [◀◀] or [▶▶] button.

Canceling Direct Access Tuning

Press the [DIRECT] button on the remote.



- If you make no button operation for 10 seconds, the Direct Access Tuning mode is automatically canceled.
- You can set up to Channel number 223.
- If there is no signal in the input Channel, "NO CHANNEL" appears.
- If you cannot receive any signal in the input Channel due to a bad condition on radio wave or another problem, "Acquiring Signal" appears.

Selecting the Preset Band

Press the [FM] button.

Each time the button is pressed the preset band switches between the SR1, SR2, SR3 and SR4.

Channel Preset Memory

Putting the channel in the memory.

1 Select the preset band

Press the [FM] button.

2 Select the channel to put in the memory

Press the [◀◀] or [▶▶] button.

3 Select the key function section

Press the [NEXT] button.

Repeatedly press the button until "[1]" — "[6]" are displayed above the [1] — [6] buttons.

Refer to <Notes on Multi-function Key System> (page 8).

4 Put the channel in the memory

Press the desired [1] — [6] button for at least 2 seconds.

The preset number display blinks 1 time.

On each band, 1 channel can be put in the memory on each [1] — [6] button.



Only the channel number is stored. Category information is not stored.

Text Scroll for Sirius tuner source

Scrolls the displayed channel name and other items.

Press the [SCRL] button.

Preset Tuning

Calling up the channels in the memory.

1 Select the preset band

Press the [FM] button.

2 Select the key function section

Press the [NEXT] button.

Repeatedly press the button until "[1]" — "[6]" are displayed above the [1] — [6] buttons.

3 Call up the channel

Press the desired [1] — [6] button.

Channel Scan

Every receivable Channel is checked for 10 seconds.

1 Start Channel Scan

Press the [AUTO] button for at least 2 seconds.
The channel number display blinks.

2 Release it when the song you want to listen to is received

Press the [AUTO] button for at least 2 seconds.

Menu system

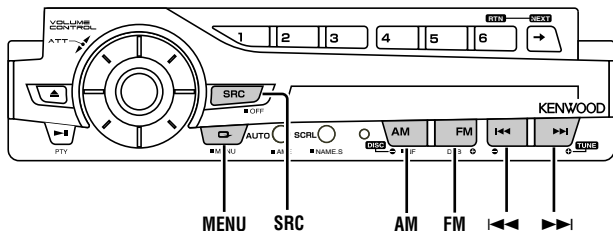

KDC-X969

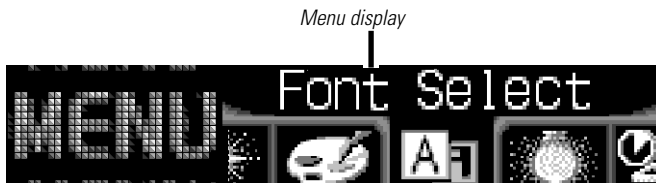

KDC-X869/KDC-MP922

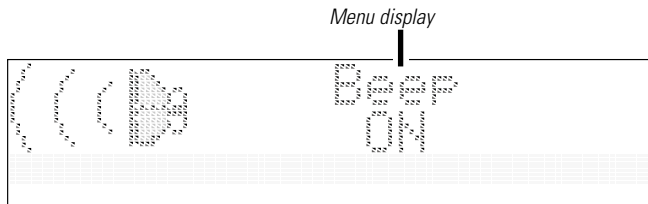

Menu System

Setting during operation beep sound etc. functions. The Menu system basic operation method is explained here. The reference for the Menu items and their setting content is after this operation explanation.

1 Enter Menu mode

Press the [MENU] button for at least 1 second.
"MENU" is displayed.

2 Select the menu item

Press the [FM] or [AM] button.
Example: When you want to set the beep sound select the "Beep" display.

3 Set the menu item

Press the [◀◀] or [▶▶] button.
Example: When "Beep" is selected, each time the button is pressed it switches "Beep:ON"/"Beep ON" or "Beep:OFF"/"Beep OFF". Select 1 of them as the setting.

You can continue by returning to step 2 and setting other items.

4 Exit Menu mode

Press the [MENU] button.



When other items that are applicable to the basic operation method above are displayed afterwards their setting content chart is entered. (Normally the uppermost setting in the chart is the original setting.)

Also, the explanation for items that aren't applicable (<Manual Clock Adjustment>etc.) are entered step by step.

Security Code

<In Standby mode>

Because authorization by the Security Code is required when it's removed from the vehicle, personalizing this unit is by using the

Security Code is a help in preventing theft.



When the Security Code function is activated, the code can't be changed and the function can't be released.
Note, the Security Code can be set as the 4 digit number of your choice.

1 Enter Standby

Press the [SRC] button.
Select the "ALL OFF" display.

2 Enter Menu mode

Press the [MENU] button for at least 1 second.
When "MENU" is displayed, "Security" is displayed.

3 Enter Security Code mode

Press the [◀◀] or [▶▶] button for at least 1 second.
When "ENTER" is displayed, "CODE" is displayed.

4 Select the digits to enter

Press the [◀◀] or [▶▶] button.

5 Select the Security Code numbers

Press the [FM] or [AM] button.

6 Repeat steps 4 and 5, and complete the Security Code.

7 Confirm the Security Code

Press the [▶▶] button for at least 3 seconds.
When "RE-ENTER" is displayed, "CODE" is displayed.

8 Do the step 4 through 7 operation, and reenter the Security Code.

"APPROVED" is displayed.
The Security Code function activates.



When the wrong Code is entered in steps 4 through 6, repeat from step 4.

Press the Reset button and when it's removed from the battery power source

1 Turn the power ON.

2 Do the step 4 through 7 operation, and enter the Security Code.

"APPROVED" is displayed.
The unit can be used.

Touch Sensor Tone

Setting the operation check sound (beep sound) ON/OFF.

Display	Setting
"Beep:ON"/"Beep ON"	Beep is heard.
"Beep:OFF"/"Beep OFF"	Beep canceled.

Manual Clock Adjustment



This adjustment can be done when the <Synchronize Clock> (page 42) is set as OFF.

1 Select Clock Adjustment mode

Press the [FM] or [AM] button.
Select the "Clock Adjust" display.

2 Enter Clock Adjust mode

Press the [◀◀] or [▶▶] button for at least 1 second.
The clock display blinks.

3 Adjust the hours

Press the [FM] or [AM] button.

Adjust the minutes

Press the [◀◀] or [▶▶] button.

4 Exit Clock adjustment mode

Press the [MENU] button.

Menu system

Date Adjustment

1 Select Date Adjust mode

Press the [FM] or [AM] button.
Select the "Date Adjust" display.

2 Enter Date Adjust mode

Press the [◀◀] or [▶▶] button for at least 1 second.
The date display blinks.

3 Selecting the item (day, month, or year) to adjust

Press the [◀◀] or [▶▶] button.
The items that are blinking are items that can be adjusted.

4 Adjust each item

Press the [FM] or [AM] button.

5 Repeat step 3 and 4 operation and adjust the date.

6 Exit Date adjustment mode

Press the [MENU] button.

Date Mode

Setting the date format.

1 Select Date Mode

Press the [FM] or [AM] button.
Select the "Date Mode" display.

2 Select the date format

Press the [◀◀] or [▶▶] button.

Synchronize Clock

Synchronizing the RDS station time data and this unit's clock.

Display	Setting
"SYNC OFF"	Adjust the time manually.
"SYNC ON"	Synchronizes the time.



It takes 3 to 4 minutes to synchronize the clock.

DSI (Disabled System Indicator)

A red indicator will blink on the unit after the faceplate is removed, warning potential thieves.

Display	Setting
"DSI:ON"/"DSI ON"	LED flashes.
"DSI:OFF"/"DSI OFF"	LED OFF.

Selectable Illumination

Selecting the button illumination color as green or red.

Display	Setting
"Button:Red"/"Button Color Red"	The illumination color is red.
"Button:Green"/"Button Color Green"	The illumination color is green.

Font Type Select

Selecting the display font.

1 Select Font Type Select Mode

Press the [FM] or [AM] button.
Select the "Font Select" display.

2 Select the font

Press the [◀◀] or [▶▶] button.

Dimmer

Dimming this unit's display automatically when the vehicle light switch is turned ON.

Display	Setting
"Dimmer:ON"/"Dimmer ON"	The display dims.
"Dimmer:OFF"/"Dimmer OFF"	The display doesn't dim.

OFF Wait Time Setting

Setting the time until the faceplate hide operation starts after the power is turned OFF.

The faceplate can be removed only during the set time period.

Display and Setting

"Off Wait: 0sec"/"Off Wait 0sec"
⋮
"Off Wait: 3sec"/"Off Wait 3sec" (Original setting)
⋮
"Off Wait:25sec"/"Off Wait 25sec"

Eject angle setting

<In Standby mode>

This function sets the opening and closing operation of a panel when a disc is inserted and when it is ejected.

Display	Setting
"Eject Angle:Slope"/ "Eject Angle Slope"	Opens and closes the panel while maintaining the angle of the control panel to the set angle.
"Eject Angle:Level"/ "Eject Angle Level"	Opens and closes the panel after setting the angle of the control panel to the horizontal position.

System Q Setting

Setting display/don't display for the System Q factors (Bass center frequency, Bass Q factor, Bass extend, Middle center frequency, Middle Q factor, and Treble center frequency) in Audio control.

Display	Setting
"System Q:ON"/ "System Q ON"	The System Q factors are displayed.
"System Q:OFF"/ "System Q OFF"	The System Q factors aren't displayed.

Menu system

Built-in Amp Mute Setting <In Standby mode>

Toggles ON or OFF the mute control on the built-in amplifier.
Turning ON this control enhances the preout quality.

Display	Setting
"AMP Mute:OFF"/ "AMP Mute OFF"	The built-in amplifier activates.
"AMP Mute:ON"/ "AMP Mute ON"	The built-in amplifier deactivates.

Function of the KDC-X969/KDC-X869

B.M.S. (Bass Management System)

Adjust the bass boost level of the external amplifier using the main unit.

Display	Setting
"AMP Bass:Flat"/"AMP BASS Flat"	Bass boost level is flat.
"AMP Bass:+6"/"AMP BASS +6"	Bass boost level is low (+6dB).
"AMP Bass:+12"/"AMP BASS +12"	Bass boost level is mid (+12dB).
"AMP Bass:+18"/"AMP BASS +18"	Bass boost level is high (+18dB).



- Refer to the catalog or instruction manual for power amplifiers that can be controlled from this unit.
- For amplifiers there are the model that can be set from Flat to +18 dB, and the model that can be set from Flat to +12 dB.
When an amplifier that can only be set to +12 is connected to the unit, "AMP Bass:+18"/"AMP BASS +18" won't work correctly even if it's selected.

Function of the KDC-X969/KDC-X869

B.M.S. Frequency Offset

Setting the central frequency boosted by B.M.S.

Display	Setting
"AMP FRQ:Normal"/"AMP FRQ Normal"	Boost with the normal central frequency
"AMP FRQ:Low"/"AMP FRQ Low"	Drop the normal central frequency 20%

Traffic Information

Switching to traffic information automatically when a traffic bulletin starts even when you aren't listening to the radio.

Display	Setting
"TI:OFF"/"TI OFF"	The Traffic Information function is OFF.
"TI:ON"/"TI ON"	The Traffic Information function is ON.

When it's ON, "Traffic Info" is displayed.

When a traffic bulletin starts, "Traffic Info" is displayed it and it switches to traffic information.



- During reception of a AM station when the Traffic Information function is turned on ON it switches to a FM station.
- During reception of traffic information the adjusted volume is automatically remembered, and the next time it switches to traffic information it's automatically the remembered volume.

Receiving other traffic information stations (In tuner source)

Press the [◀◀] or [▶▶] button.



- Traffic information station switching can be done when listening to the radio.

CRSC (Clean Reception System Circuit) <In FM reception>

Temporarily have reception switched from stereo to mono to reduce multi-path noise when listening to the FM station.

Display	Setting
"CRSC:ON"/"CRSC ON"	The CRSC is ON.
"CRSC:OFF"/"CRSC OFF"	The CRSC is OFF.

 Strong electrical fields (such as from power lines) may cause unstable sound quality when CRSC is turned ON. In such a situation, turn it OFF.

Sirius ID [ESN] display <In Sirius tuner source>

Displaying the Sirius ID(Electronic Serial Number) display

Display
"ESN:*****"/"ESN Watch *****"

 **Serial & Sirius ID [ESN]**
It is especially important to retain the unit serial number and the electronic Sirius Identification number for service activation and potential future service changes.

Text Scroll

Setting the displayed text scroll.

Display	Setting
"Scroll:Auto"/"Scroll Auto"	Repeats scroll.
"Scroll:Manual"/"Scroll Manual"	Scrolls when the display changes.



The text scrolled is shown below.

- CD text
- Folder name/ File name/ Song title/ Artist name/ Album name
- MD title
- Radio text
- Text for the Sirius tuner source, including Channel name, etc.

Built-in Auxiliary input Setting

Set the Built-in Auxiliary Input function.

Display	Setting
"Builtin AUX:OFF"/"Builtin AUX OFF"	When selecting the source there's no Auxiliary Input.
"Builtin AUX:ON"/"Builtin AUX ON"	When selecting the source there's Auxiliary Input.

CD Read Setting

<In Standby mode>

When there is a problem on playing a CD with special format, this setting play the CD by force.

Display	Setting
"CD READ:1"/"CD READ 1"	Play CD and MP3/WMA.
"CD READ:2"/"CD READ 2"	Play CD by force.



Setting "CD READ:2"/"CD READ 2" cannot play MP3/WMA. Some music CDs may not be played back even in the "CD READ:2"/"CD READ 2" mode.

Menu system

Function of the KDC-X969

Picture downloading

<In Standby mode>

Downloading movies and wallpapers. Downloaded pictures can be used for the display of this unit.

1 Inset a CD-R/CD-RW.

Insert a CD-R/CD-RW containing files to be downloaded into this unit.

Refer to <Playing CD & MP3/WMA> (page 32) for details.

Our URL

<http://www.kenwoodusa.com/register/oe_l_software.jsp>

describes how to make CD-R/CD-RW.



Picture downloading is not possible when <CD Read Setting> (page 45) is set to "CD READ:2".

Change the setting to "CD READ:1".

2 Enter Standby

Press the [SRC] button.

Select the "ALL OFF" display.

3 Enter Menu mode

Press the [MENU] button for at least 1 second.

"MENU" is displayed.

4 Select the downloading mode

Press the [FM] or [AM] button.

Select the "Disp Data DL" display.

5 Enter the downloading mode

Press the [◀◀] or [▶▶] button.

"File Check!!" is displayed.

6 Select files to be downloaded

Press the [FM] or [AM] button.

7 Start downloading

Press the [◀◀] or [▶▶] button for at least 2 seconds.

"Downloading" is displayed.

When the downloading finishes, "Finished Download" is displayed.



Picture download may take as long as 10 minutes.

Quantity



Canceling Downloading

Press the [MENU] button.

8 Exit the downloading mode

Press the [MENU] button.



- Do not operate this unit, while "Data Writing" is displayed, to prevent data from being damaged.
- The number of files that can be downloaded.
 - Downloaded movie: 1 file
 - Wallpaper: 1 file
- When a new movie is downloaded, it is overwritten to the currently downloaded movie. Also, when a new wallpaper is downloaded, it is overwritten to the currently downloaded wallpaper. There is no way to delete the downloaded pictures.
- The downloaded pictures can be used for display. <Right Side Graphic Display Switching> (page 17) <Wallpaper selecting> (page 18)
- When you can't download the pictures to this unit, there may be a problem with the CD-R/CD-RW write method. Refer to the URL <http://www.kenwoodusa.com/register/oe_l_software.jsp>, and rewrite the CD-R/CD-RW.

Basic Operations of remote

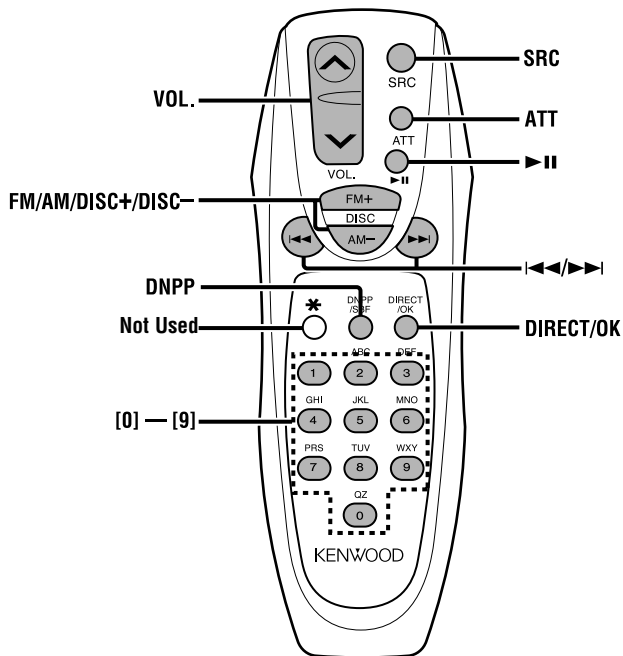

Loading and Replacing the battery

Use two "AA"-size batteries.

Slide the cover while pressing downwards to remove it as illustrated.

Insert the batteries with the + and - poles aligned properly, following the illustration inside the case.

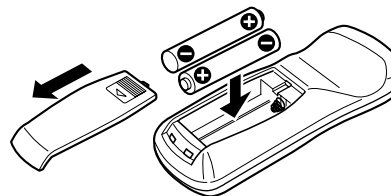

▲WARNING

Store unused batteries out of the reach of children. Contact a doctor immediately if the battery is accidentally swallowed.



Do not set the remote on hot places such as above the dashboard.

Basic operations

[VOL.] buttons

Adjusting the volume.

[SRC] button

Each time the button is pressed the source switches.

For the source switching order refer to <Selecting the Source> (page 10).

[ATT] button

Turning the volume down quickly.

When it is pressed again it returns to the previous level.

Basic Operations of remote

In Tuner source

[FM]/ [AM] buttons

Select the band.
Each time the [FM] button is pressed it switches between the FM1, FM2, and FM3 bands.

[◀◀]/ [▶▶] buttons

Tune up or down band.

[0] — [9] buttons

Press buttons [1] — [6] to recall preset stations.

[DIRECT] button

Enters and cancels the <Direct Access Tuning> (page 28) mode.

[▶II] button

Enters and cancels the <PTY (Program Type)> (page 30) mode.

[DNPP]/ [OK] button

Enters and cancels the <SNPP (Station Name Preset Play)> (page 29) mode.

[0] — [9] buttons

When in <Direct Track/File Search> (page 33) and <Direct Disc Search> (page 34), enter the track/file/disc number.

In Sirius tuner source

[FM] buttons

Select the preset band.

[◀◀]/ [▶▶] buttons

Search up or down channel.

[0] — [9] buttons

Press buttons [1] — [6] to recall preset channels.

[DIRECT] button

Enters and cancels the <Direct Access Tuning> (page 38) mode.

In Disc source

[◀◀]/ [▶▶] buttons

Doing track/file forward and backward.

[DISC+]/ [DISC-] buttons

Doing disc/folder forward and backward.

[▶II] button

Each time the button is pressed the song pauses and plays.

[DNPP]/ [OK] button

Enters and cancels the <DNPP (Disc Name Preset Play)> (page 35) mode.

Accessories

External view

..... Number of items

①

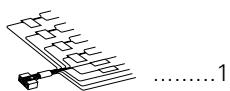

.....1

②



.....2

③

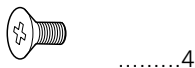

.....4

External view

..... Number of items

④



.....4

⑤



.....2



Do not use any accessories other than those provided with your unit. If you use other accessories, you may damage the unit.

Installation Procedure

1. To prevent a short circuit, remove the key from the ignition and disconnect the \ominus battery.
2. Make the proper input and output wire connections for each unit.
3. Connect the speaker wires of the wiring harness.
4. Connect the wiring harness wires in the following order: ground, battery, ignition.
5. Connect the wiring harness connector to the unit.
6. Install the unit in your car.
7. Reconnect the \ominus battery.
8. Turn the vehicle's ignition key on and open the panel.
9. Press the reset button.

⚠WARNING

If you connect the ignition wire (red) and the battery wire (yellow) to the car chassis (ground), you may cause a short circuit, that in turn may start a fire. Always connect those wires to the power source running through the fuse box.

⚠CAUTION

- If your car's ignition does not have an ACC position, connect the ignition wires to a power source that can be turned on and off with the ignition key. If you connect the ignition wire to a power source with a constant voltage supply, as with battery wires, the battery may die.
- If the console has a lid, make sure to install the unit so that the faceplate will not hit the lid when closing and opening.
- If the fuse blows, first make sure the wires aren't touching to cause a short circuit, then replace the old fuse with one with the same rating.
- Insulate unconnected wires with vinyl tape or other similar material. To prevent a short circuit, do not remove the caps on the ends of the unconnected wires or the terminals.
- Connect the speaker wires correctly to the terminals to which they correspond. The unit may be damaged or fail to work if you share the \ominus wires or ground them to any metal part in the car.
- When only two speakers are being connected to the system, connect the connectors either to both the front output terminals or to both the rear output terminals (do not mix front and rear). For example, if you connect the \oplus connector of the left speaker to a front output terminal, do not connect the \ominus connector to a rear output terminal.
- After the unit is installed, check whether the brake lamps, blinkers, wipers, etc. on the car are working properly.
- Mount the unit so that the mounting angle is 30° or less.

Connecting Wires to Terminals

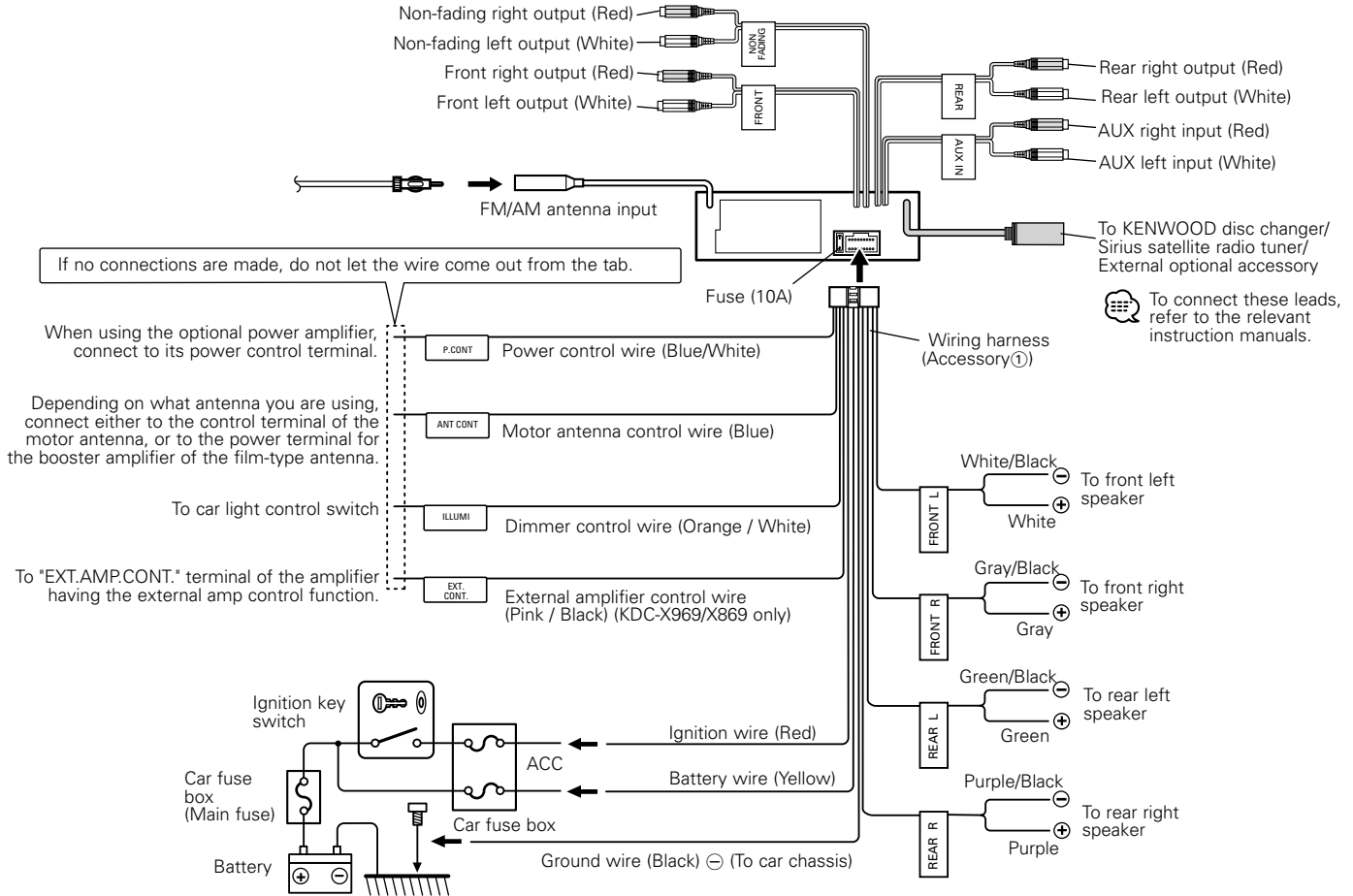

Installation (non-Japanese cars)

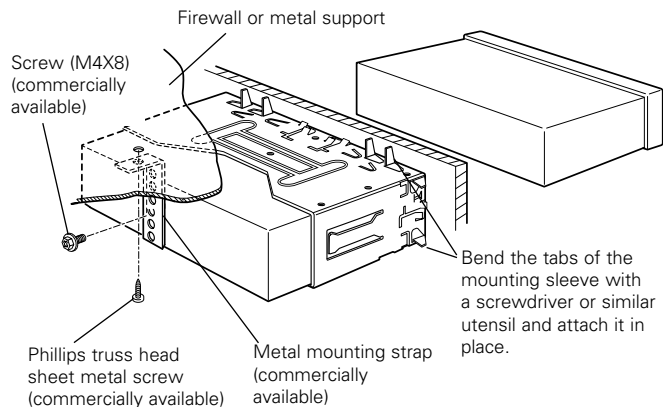

 Make sure that the unit is installed securely in place. If the unit is unstable, it may malfunction (for example, the sound may skip).

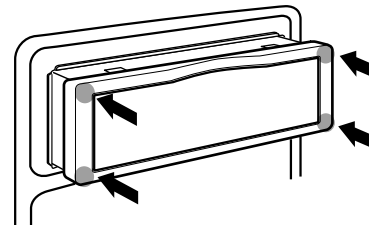

-  To attach this unit, make sure the front of the control panel faces you and fit it into the mounting sleeve by pressing the four corners of the hard rubber frame at the same time. Do not apply strong pressure to other sections than the corners; otherwise troubles such as the impossibility of opening or closing the panel may result.
- The hollow at the center of the rubber frame is designed to make it easier to remove discs. If you do not want the hollow to be visible, mount the rubber frame in the opposite direction (with the flat side at the top instead of the bottom).

Installation (Japanese-cars)

After aligning the factory-installed radio bracket, tighten the screws.

For Toyota Car



Accessory④
for Toyota car

For Nissan Car



Accessory③
for Nissan car



Damage to the unit will result from using screws other than those provided.

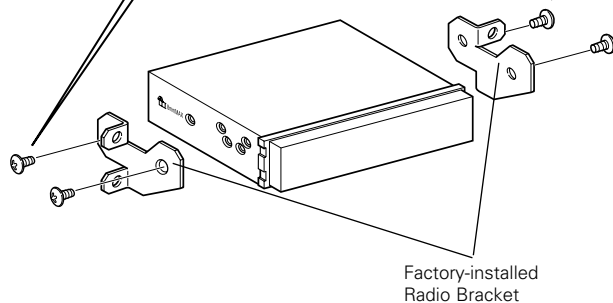

Removing the Unit

■ Removing the hard rubber frame

- Engage the catch pins on the removal tool and remove the two locks on the upper level. Upper the frame and pull it forward as shown in the figure.

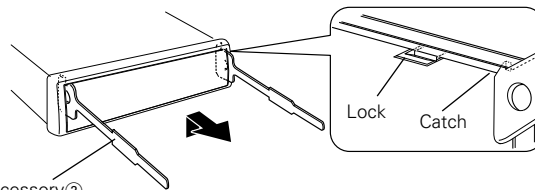

Accessory②
Removal tool

- When the upper level is removed, remove the lower two locations.

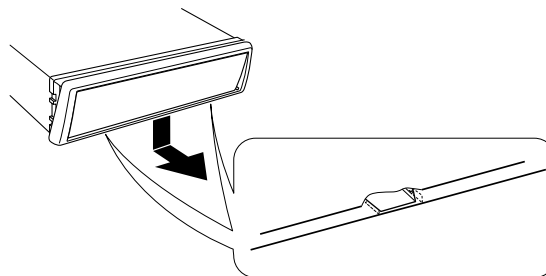

The frame can be removed from the bottom side in the same manner.

■ Removing the Unit

- 1 Refer to the section <Removing the hard rubber frame> and then remove the hard rubber frame.
- 2 Remove the screw (M4 × 8) on the back side.
- 3 Insert the two removal tools deeply into the slots on each side, as shown.

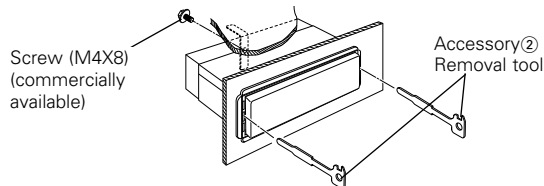

- 4 Lower the removal tool toward the bottom, and pull out the unit halfway while pressing towards the inside.

 Be careful to avoid injury from the catch pins on the removal tool.

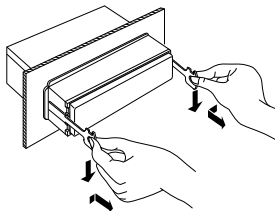

- 5 Pull the unit all the way out with your hands, being careful not to drop it.

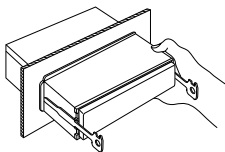

Locking the Backpanel to the unit

- 1 Refer to the Removing the Backpanel function of the section on <Theft Deterrent Panel> (page 25) and remove the Backpanel.
- 2 Insert the panel lock screws into the holes at the sides of the panel.

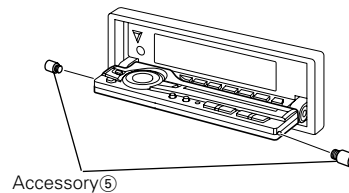

- 3 Reattach the Backpanel.

 Never insert the panel lock screws (M2 X 1.5 mm) in any other screw holes than the one specified. If you insert them in another hole, it will contract and may cause damage to the mechanical parts inside the unit.

Troubleshooting Guide

What might seem to be a malfunction in your unit may just be the result of slight misoperation or miswiring. Before calling service, first check the following table for possible problems.

General

? The power does not turn ON.

- ✓ The fuse has blown.
 - ☞ After checking for short circuits in the wires, replace the fuse with one with the same rating.

? There's a source you can't switch.

- ✓ There's no media inserted.
 - ☞ Set the media you want to listen to. If there's no media in this unit, you can't switch to each source.
- ✓ The Disc changer isn't connected.
 - ☞ Connect the Disc changer. If the Disc changer isn't connected to it's input terminal, You can't switch to an external disc source.

? The memory is erased when the ignition is turned OFF.

- ✓ The ignition and battery wire are incorrectly connected.
 - ☞ Connect the wire correctly, referring to the section on <Connecting Wires to Terminals>.

? There's no loudness effect.

- ✓ You're using Non-fading preout.
 - ☞ Loudness has no effect in Non-fading preout.
- ✓ The <System Q> (page 12) is set to SRS WOW.
 - ☞ Turn it to the other items.

? Even if Loudness is turned ON, high-pitched tone isn't compensated for.

- ✓ Tuner source is selected.
 - ☞ High-pitched tone isn't compensated for when in Tuner source.

? The Bass center frequency, Bass quality factor, Bass extend, Middle center frequency, Middle quality factor, and Treble center frequency can't be adjusted.

- ✓ The <System Q Setting> (page 43) is set OFF.
 - ☞ Set it ON.

? No sound can be heard, or the volume is low.

- ✓ The fader or balance settings are set all the way to one side.
 - ☞ Center the fader and balance settings.
- ✓ The input/output wires or wiring harness are connected incorrectly.
 - ☞ Reconnect the input/output wires or the wiring harness correctly. See the section on <Connecting Wires to Terminals>.
- ✓ The values of Volume offset are low.
 - ☞ Turn up the Volume offset, referring to the section on <Audio control> (page 12).
- ✓ The <Built-in Amp Mute Setting> (page 44) is ON.
 - ☞ Turn it OFF.

? The sound quality is poor or distorted.

- ✓ One of the speaker wires is being pinched by a screw in the car.
 - ☞ Check the speaker wiring.
- ✓ The tape head is dirty.
 - ☞ Clean the tape head.
- ✓ The speakers are not wired correctly.
 - ☞ Reconnect the speaker wires so that each output terminal is connected to a different speaker.

? Non-fading output, Non-fading Low Pass Filter and Non-fading setting can't be done.

- ✓ The <Non-fading output> (page 12) is OFF.
 - ☞ Turn it ON.
- ✓ The <Dual zone system> (page 26) is ON.
 - ☞ Turn it OFF.

? There's no Front High Pass Filter and Rear High Pass Filter effect.

- ✓ The Non-fading preout is being used.
 - ☞ There's no effect in Non-fading preout.

? The Touch Sensor Tone doesn't sound.

- ✓ The preout jack is being used.
 - ☞ The Touch Sensor Tone can't be output from the preout jack.

? Even though Synchronize Clock is ON, the clock can't be adjusted.

- ✓ The received RDS station isn't sending time data.
 - ☞ Receive another RDS station.

? The Dimmer function doesn't work.

- ✓ The Dimmer wire isn't connected correctly.
 - ☞ Check the Dimmer wire connection.
-

? The panel is not hidden even when the power is turned off.

- ✓ The protection function for preventing fingers or other things from getting caught in between the panel and this unit has been activated.
 - ☞ Turn off the power again.
-

? There are no audio control effects.

- ✓ WOW item on <Audio Control> (page 12) and SRS WOW item on <System Q> (page 12) have no effect in rear output.
 - ☞ ---
-

Tuner source

? Radio reception is poor.

- ✓ The car antenna is not extended.
 - ☞ Pull the antenna out all the way.
 - ✓ The antenna control wire is not connected.
 - ☞ Connect the wire correctly, referring to the section on <Connecting Wires to Terminals>.
-

? The desired frequency can't be entered with the Direct Access Tuning.

- ✓ A station that can't be received is being entered.
 - ☞ Enter a station that can be received.
 - ✓ You're trying to enter a frequency with a 0.01 MHz unit.
 - ☞ What can be designated in the FM band is to 0.1 MHz.
-

? It isn't the set Traffic information sound volume.

- ✓ The set sound volume is less than the tuner sound volume.
 - ☞ If the tuner sound volume is louder than the set sound volume, the tuner sound volume is used.
-

Disc source

? "AUX1" is displayed without achieving External disc control mode.

- ✓ Unsupported disc changer is connected.
 - ☞ Use the disc changer mentioned in the IMPORTANT INFORMATION of the section on <Safety precautions> (page 4).
-

? The specified disc does not play, but another one plays instead.

- ✓ The specified CD is quite dirty.
 - ☞ Clean the CD.
 - ✓ The disc is loaded in a different slot from that specified.
 - ☞ Eject the disc magazine and check the number for the specified disc.
 - ✓ The disc is severely scratched.
 - ☞ Try another disc instead.
-

? A CD ejects as soon as it is loaded.

- ✓ The CD is quite dirty.
 - ☞ Clean the CD, referring to the CD cleaning of the section on <About CDs> (page 9).
-

? Can't remove disc.

- ✓ The cause is that more than 10 minutes has elapsed since the vehicle ACC switch was turned OFF.
 - ☞ The disc can only be removed within 10 minutes of the ACC switch being turned OFF. If more than 10 minutes has elapsed, turn the ACC switch ON again and press the Eject button.
-

? The disc won't insert.

- ✓ There's already another disc inserted.
 - ☞ Press the [▲] button and remove the disc.
-

? Direct Search can't be done.

- ✓ Another function is ON.
 - ☞ Turn Random Play or other functions OFF.
-

? Track Search can't be done.

- ✓ For the discs/folders first or last song.
 - ☞ For each disc/folder, Track Search can't be done in the backward direction for the first song or in the forward direction for the last song.
-

Troubleshooting Guide

MP3/WMA source

? Cannot play an MP3/WMA.

- ✓ The media is scratched or dirty.
 - ⓘ Clean the media, referring to the CD cleaning of the section on <About CDs> (page 9).

? The sound skips when an MP3/WMA is being played.

- ✓ The media is scratched or dirty.
 - ⓘ Clean the media, referring to the CD cleaning of the section on <About CDs> (page 9).

- ✓ The recording condition is bad.
 - ⓘ Record the media again or use another media.

? The MP3/WMA track time isn't displayed correctly.

- ✓ ---
 - ⓘ There are times when it isn't displayed correctly according to the MP3/WMA recording conditions.

If the following situations, consult your nearest service center:

Even though the disc changer is connected, the Disc Changer source is not ON, with "AUX1" showing in the display during the Changer Mode.

The messages shown below display your systems condition.

- Eject: No disc magazine has been loaded in the changer. The disc magazine is not completely loaded.
 - ↪ Load the disc magazine properly.
 - No CD in the unit.
 - ↪ Insert the CD.
- No Disc: No disc has been loaded in the disc magazine.
 - ↪ Load a disc into the disc magazine.
- TOC Error: No disc has been loaded in the disc magazine.
 - ↪ Load a disc into the disc magazine.
 - The CD is quite dirty. The CD is upside-down. The CD is scratched a lot.
 - ↪ Clean the CD and load it correctly.
- E-05: The CD is upside-down.
 - ↪ Load the CD correctly.
- Blank Disc: Nothing has been recorded on the MD.
- No Track Disc: No tracks are recorded on the MD, although it has a title.
- E-15: Media was played that doesn't have data recorded that the unit can play.
 - ↪ Use media that has data recorded that the unit can play.
- No Panel: The faceplate of the slave unit being connected to this unit has been removed.
 - ↪ Replace it.
- E-77: The unit is malfunctioning for some reason.
 - ↪ Press the reset button on the unit. If the "E-77" code does not disappear, consult your nearest service center.
- Mecha Error: Something is wrong with the disc magazine. Or the unit is malfunctioning for some reason.
 - ↪ Check the disc magazine. And then press the reset button on the unit. If the "Mecha Error" code does not disappear, consult your nearest service center.
- E-99: The unit is malfunctioning for some reason.
 - ↪ Press the reset button on the unit. If the "E-99" code does not disappear, consult your nearest service center.

<p>Hold Error: The protective circuit in the unit activates when the temperature inside the automatic disc changer exceeds 60°C (140°F), stopping all operation. ⇨ Cool down the unit by opening the windows or turning on the air conditioner. As the temperature falls below 60°C (140°F), the disc will start playing again.</p> <p>NO NAME: Attempted to display DNPS during the CD play having no disc names preset.</p> <p>Waiting: Radio text data is being received. Text for the Sirius tuner source is being received.</p> <p>Load: Discs are being exchanged in the Disc changer.</p> <p>Reading: The unit is reading the data on the disc.</p> <p>NO ACCESS: After setting it in the Disc Changer, DNPP was done without having it been played at least 1 time.</p> <p>IN (Blink): The CD player section is not operating properly. ⇨ Reinsert the CD. If the CD cannot be ejected or the display continues to flash even when the CD has been properly reinserted, please switch off the power and consult your nearest service center.</p> <p>Unsupported File: A MP3/WMA is played with a format that this unit can't support. ⇨ ---</p> <p>Protected File: A copy-protected file is played. ⇨ ---</p> <p>Can't Download/ Download Error: This unit does not work properly for some reason. ⇨ Press the reset button to download it again. If this error is still displayed, consult a local Kenwood dealer.</p>	<p>No Display File: No file that can be downloaded is contained in the CD-ROM. ⇨ Make sure that a files created with referring to <http://www.kenwoodusa.com/register/oeel_software.jsp> is contained in the CD-ROM. Do not delete the extension (.kbn/.KBN) created when the file was created. Picture downloading was performed with the <CD Read Setting> (page 45) set to "CD READ:2". ⇨ Change the setting to "CD READ:1".</p> <p>Incorrect File: The file selected to be downloaded has a format that this unit cannot read. ⇨ Recreate the file.</p> <p>Writing Error: Writing failed while the file was downloaded. ⇨ Try the downloading again.</p>
--	--

Specifications

Specifications subject to change without notice.

FM tuner section

Frequency range (200 kHz space)	87.9 MHz – 107.9 MHz
Usable sensitivity (S/N = 30dB)	9.3dBf (0.8 μ V /75 Ω)
Quieting Sensitivity (S/N = 50dB)	15.2dBf (1.6 μ V /75 Ω)
Frequency response (\pm 3.0 dB)	30 Hz – 15 kHz
Signal to Noise ratio (MONO)	70 dB
Selectivity (\pm 400 kHz)	\geq 80 dB
Stereo separation (1 kHz)	40 dB

AM tuner section

Frequency range (10 kHz space)	530 kHz – 1700 kHz
Usable sensitivity (S/N = 20dB)	28 dB μ (25 μ V)

CD player section

Laser diode	GaAlAs (λ =780 nm)
Digital filter (D/A)	8 Times Over Sampling
D/A Converter	1 Bit
Spindle speed	1000 – 400 rpm (CLV 2times)
Wow & Flutter	Below Measurable Limit
Frequency response (\pm 1 dB)	10 Hz – 20 kHz
Total harmonic distortion (1 kHz)	0.01 %
Signal to Noise ratio (1 kHz)	105 dB
Dynamic range	93 dB
Channel separation	95 dB
MP3 decode	Compliant with MPEG-1.0/2.0/2.5 Audio Layer-3
WMA decode (KDC-X969)	Compliant with Windows Media Audio

Audio section

Maximum output power	50 W x 4
Full Bandwidth Power (at less than 1% THD)	22 W x 4
Tone action	
Bass :	100 Hz \pm 10 dB
Middle :	1 kHz \pm 10 dB
Treble :	10 kHz \pm 10 dB
Preout level / Load (during disc play)	5000 mV/10 k Ω
Preout impedance	80 Ω

Auxiliary input

Frequency response (\pm 1 dB)	20 Hz – 20 kHz
Input Maximum Voltage	1200 mV
Input Impedance	100 k Ω

General

Operating voltage (11 – 16V allowable)	14.4 V
Current consumption	10 A
Installation Size (W x H x D)	178 x 50 x 165 mm
	7 x 1-15/16 x 6-1/2 inch
Weight	3.75 lbs (1.70 kg)

KENWOOD